



125 years of innovation

Roundness Filters and Harmonics

Contents

- **Harmonics - Terminology**
- **What is an Harmonic?**
 - Harmonic Groups
- **Filters**
 - Standard Filter Values
 - 2CR Filter
 - Gaussian Filter
 - Comparison of 2CR to Gaussian Filter
 - ISO Stylus Tip Diameter
 - ISO Choice of Filter / Tip diameter
- **Harmonic Analysis**
 - Amplitude Display
 - Histogram Display
- **Summary**

Terminology

Undulations Per Revolution (UPR)

Undulations Produced by Manufacturing Process

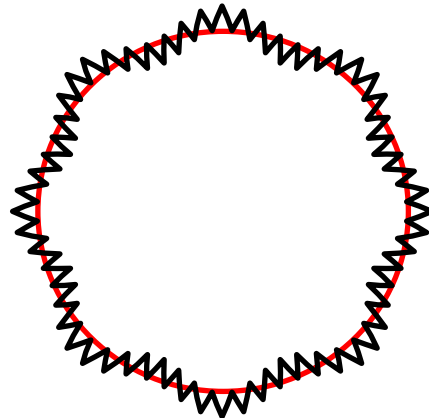

- Any roundness profile can be broke down to its constituent parts which consist of undulations around the profile
- These undulations are usually produced by the manufacturing processes and can tell us a lot about the way in which the component will function under certain conditions. We can also control the manufacturing process with this information.

Terminology

Wavelengths on the Surface = Harmonics =UPR

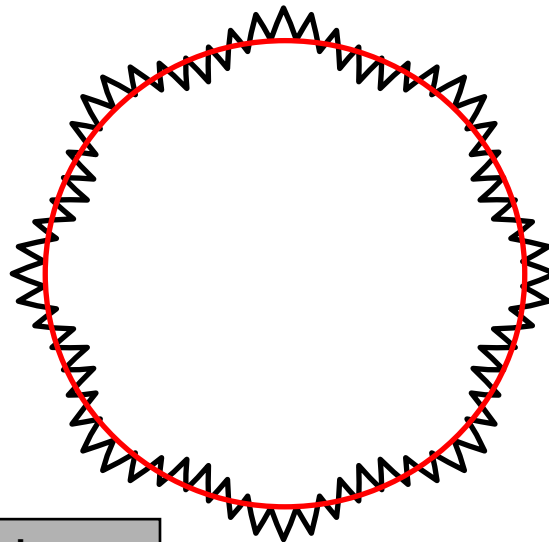

**A profile Showing a
Dominant 8th and 60th
Harmonic**

- The diagram here shows a profile consisting of a number of undulations
- These undulations can be split into individual Harmonics
- If there are 8 undulations around a circle of a repeated frequency then this would be an 8th harmonic
- This diagram here shows both an 8th and a 60th harmonic, the following pages give some examples of Harmonics and how they can be produced.

What is an Harmonic?

1st Harmonic (Eccentricity)

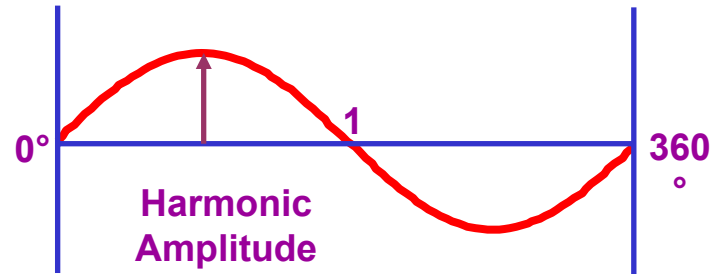

2nd Harmonic (Ovality)

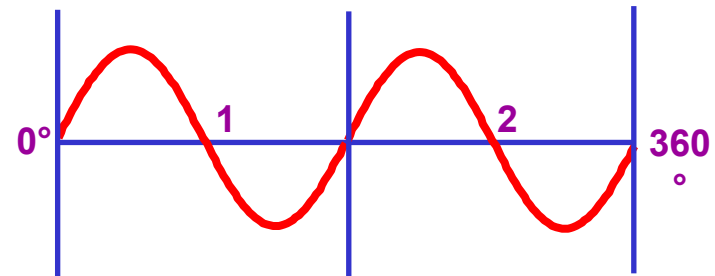

5th Harmonic

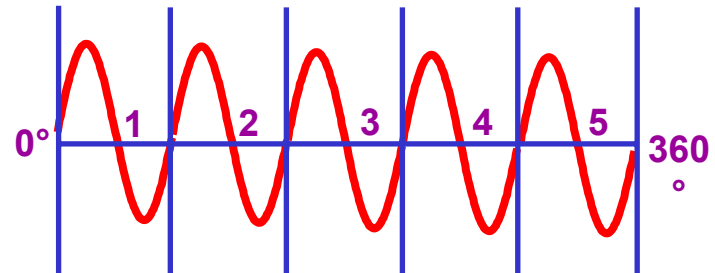

- A harmonic on a circular profile can be considered as a uniform waveform or sine wave which is superimposed on the surface of the component.
- All roundness profiles consist of a series of sine waves which are added together to produce the complete profile.

Harmonic Groups

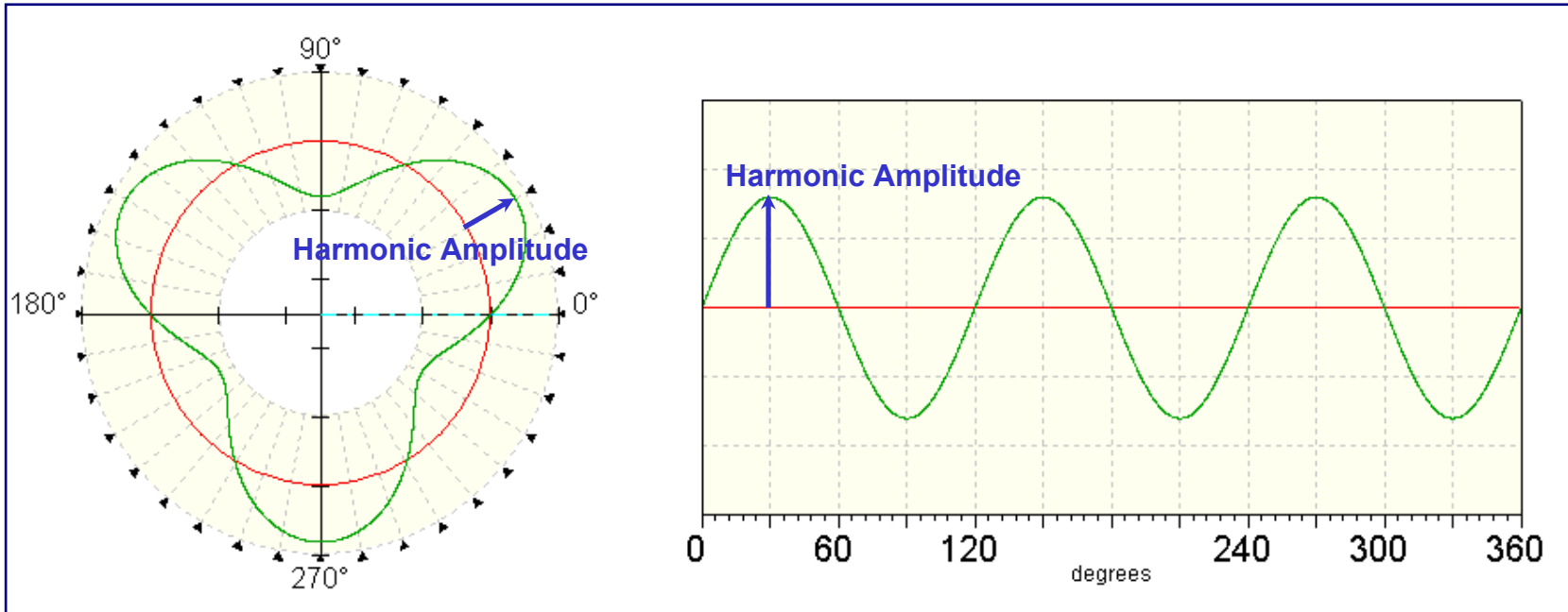

**A Roundness profile
Showing a 3rd Harmonic**

**The 3rd Harmonic Shown as
a Waveform**

- The above slide shows a profile consisting of a 3rd Harmonic only.
- The associated waveform for the 3rd Harmonic is shown on the right.
- In reality, a roundness profile will consist of many different Harmonics of varying amplitudes.

Harmonic Groups

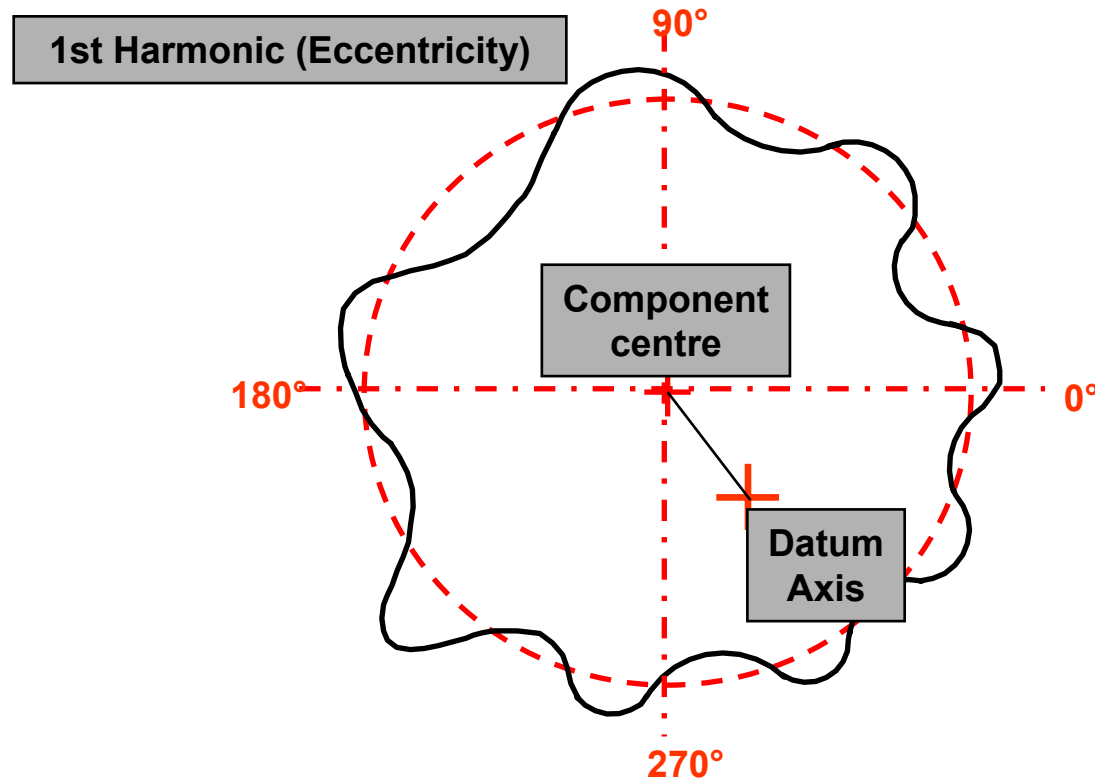

- The 1st harmonic is nothing to do with the shape of the component.
- It can be described as 1 undulation in one revolution produced by the eccentricity of the component to the datum axis.
- It should be noted at this point that the harmonic amplitude is not the concentricity but half of this which is the eccentricity.

Harmonic Groups

2nd Harmonic (Ovality)

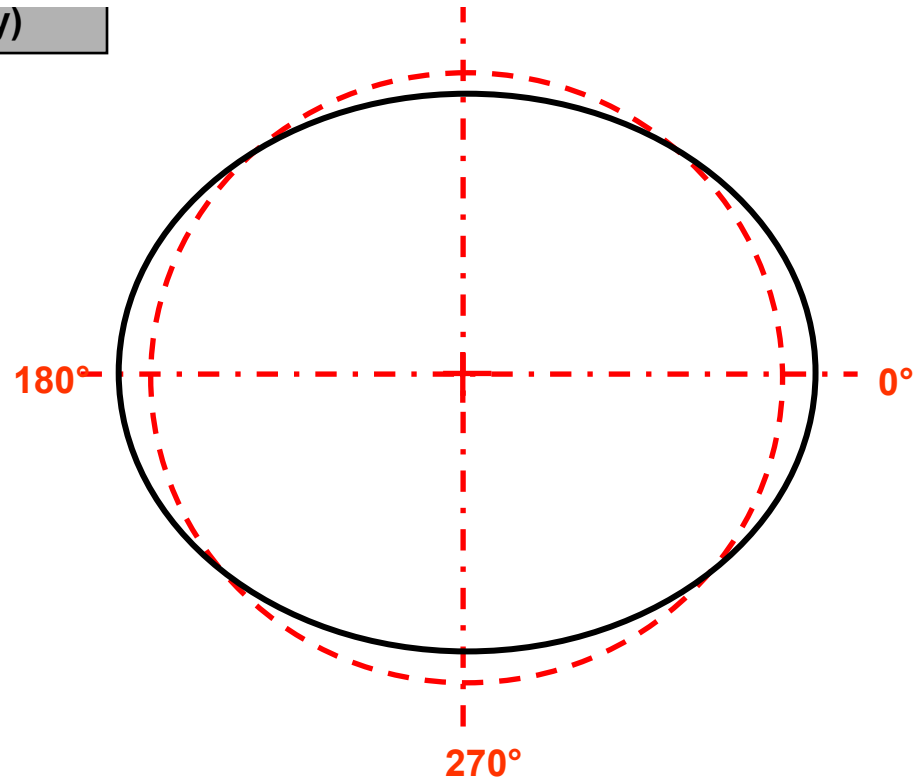
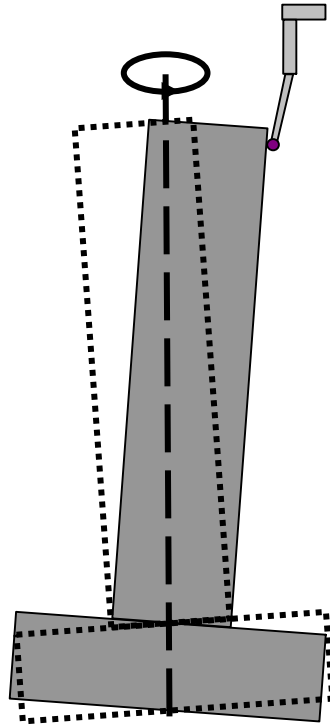

- If a part is oval this can produce a 2nd harmonic, this harmonic can also be produced due to a badly leveled component as shown above.
- An excellent example of a component with a dominant second harmonic would be a Piston, pistons are often elliptical in shape.
- It should be noted that the harmonic amplitude is not the peak to valley of that particular harmonic but half of this.
- In other words the amplitude of the 2nd harmonic shown above is half of the peak to valley of the undulation.

Harmonic Groups

3rd Harmonic (Tri-Lobed)

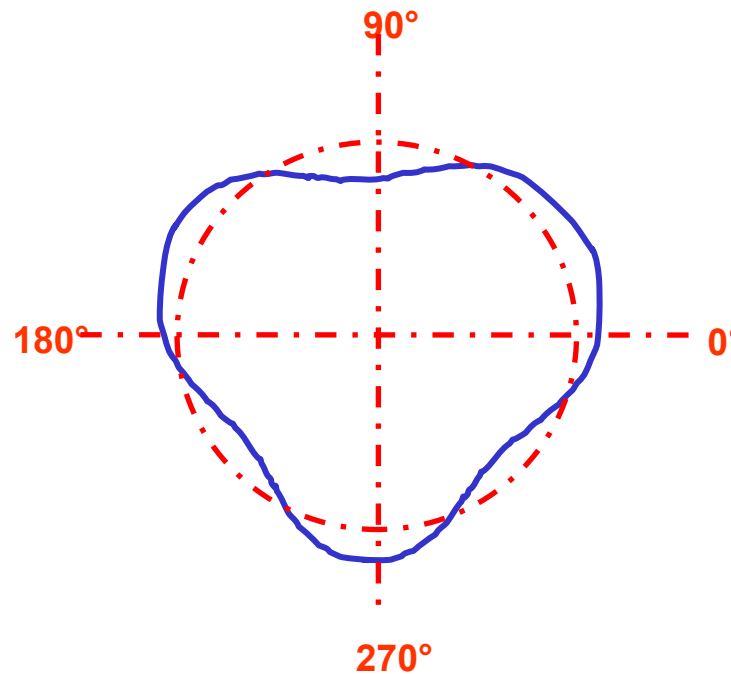
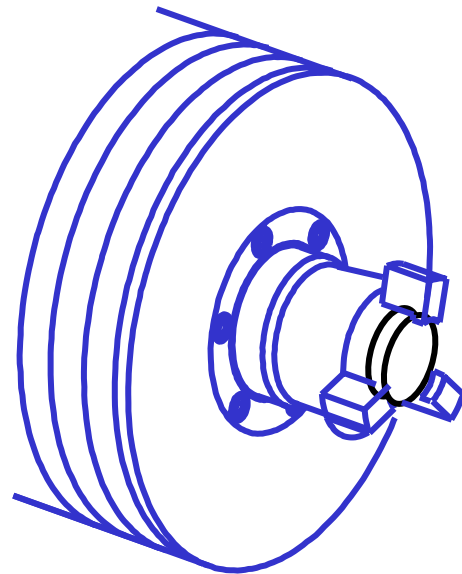

- Most lower order harmonics are produced by stress, the example above shows a 3rd harmonic induced by an over tightened chuck.
- The number of the harmonic will relate to the number of jaws in the holding device, so a 6th Harmonic could be produced by stress from a 6 jaw chuck.

Harmonic Groups

3rd Harmonic (Tri-Lobed)



Centreless Grinding

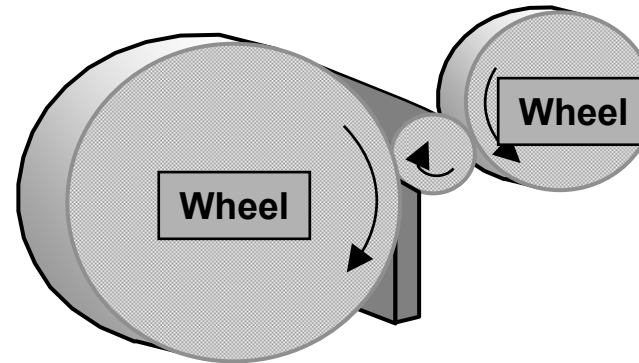
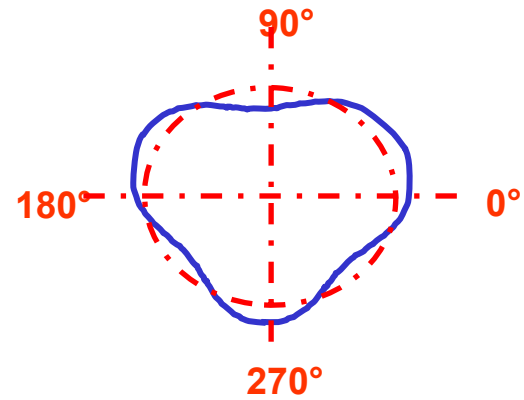

- Another classic example of an induced 3rd Harmonic is from centreless grinding.
- In the example above the component is fed between two rotating grinding wheels whilst being supported by a component support. These three points of contact produce the familiar tri lobed shape associated with centreless grinding.

Harmonic Groups

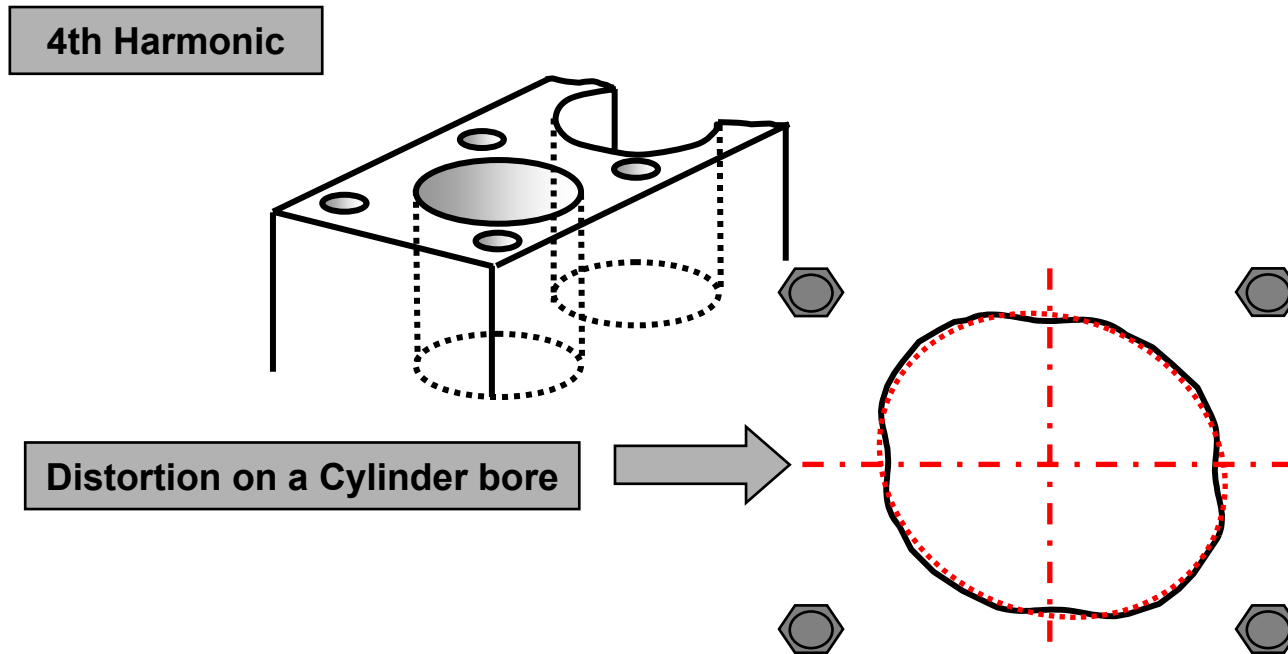

- Over tightening of bolts etc will also produce distortion, as can be seen on the cylinder liner above.
- The position of the over tightened bolts in the case above cause a dominant 4th harmonic.

Harmonic Groups

Higher Order Harmonics

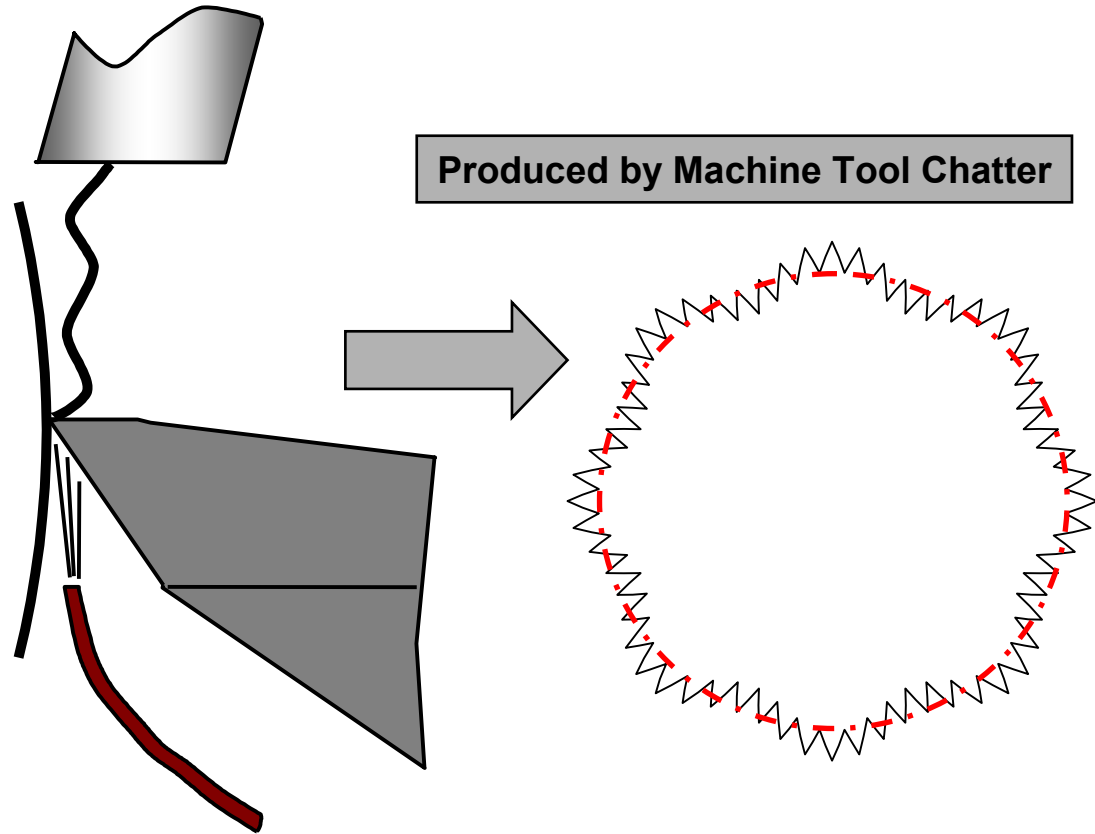

Produced by Machine Tool Chatter

- Higher order harmonics can be induced by the effects of the tool on the part, such as machine chatter.

Filters

Filters are Used to Separate Different Harmonics

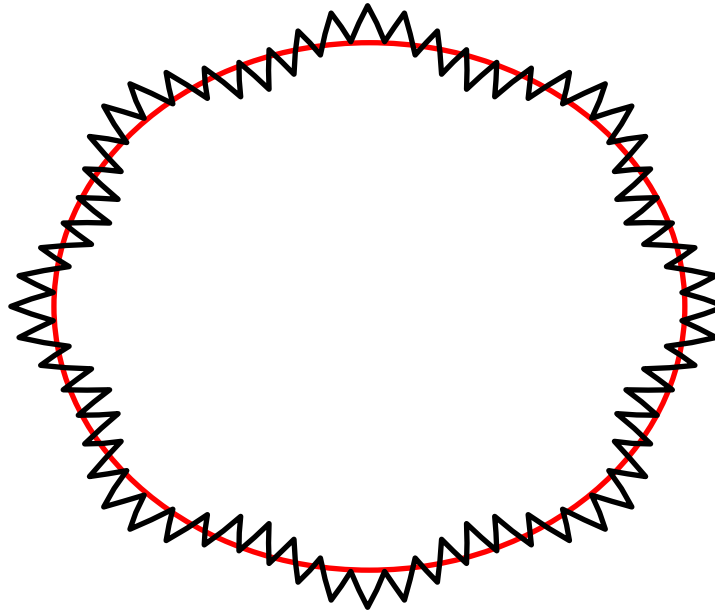

- To enable the analyst to separate the wanted from the unwanted we employ the use of filters.
- These filters assist in separating the different harmonics found on the profile.

Filters

Unfiltered Profile

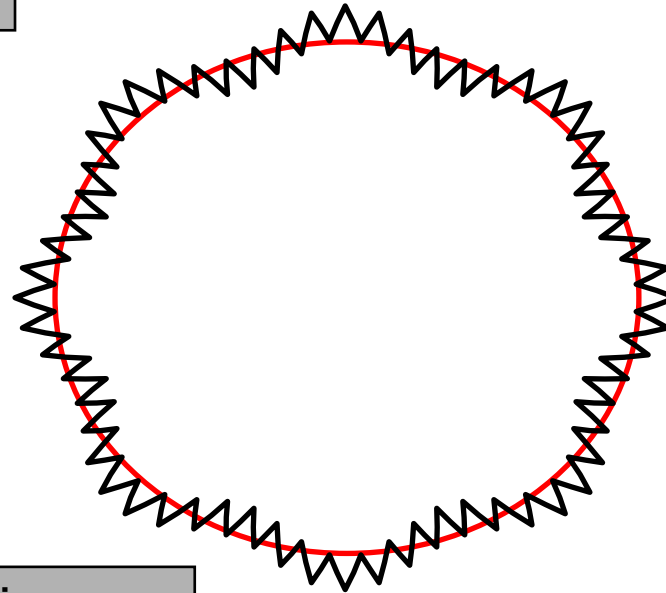

A profile Showing a Dominant 8th and 60th Harmonic

- This diagram shows the unfiltered profile collected from our roundness measuring instrument.
- In this example the profile is made up of 8th and 60th harmonics, these can be separated as follows using filters.

Standard Filter Values

Standard Filter Values

1-15 UPR

1-50 UPR

1-150 UPR

1-500 UPR

- The above filter values are internationally accepted as the standard UPR ranges for roundness analysis.
- Harmonics (UPR) outside of the selected filter ranges will be attenuated in amplitude by increasing amounts the further the harmonic is away from the selected range.

Standard Filter Values

1-15 UPR Filter

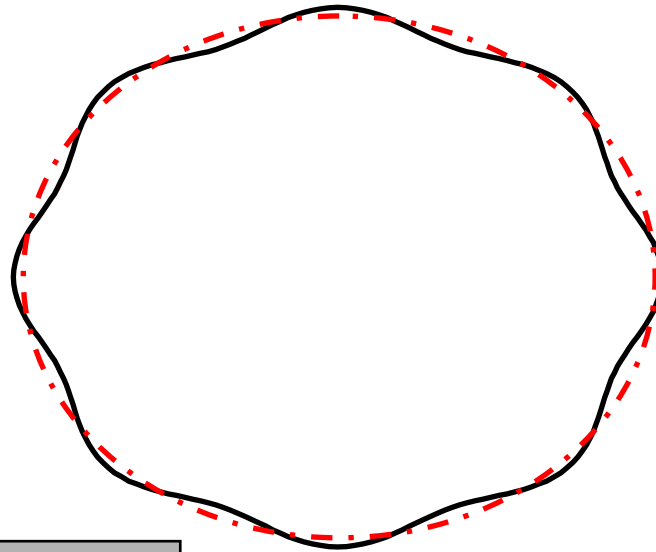

60th Harmonic Has Been
Removed

- The effect of a 1-15 filter can be seen in the diagram and in this case has suppressed undulations above the 15th harmonic, in other words the 60th harmonic has been removed leaving the 8th harmonic.
- This is a very simplistic approach to demonstrate the nature of filters, in reality there will exist harmonics above the 15th however these will be attenuated the further we go from the 15th.

Standard Filter Values

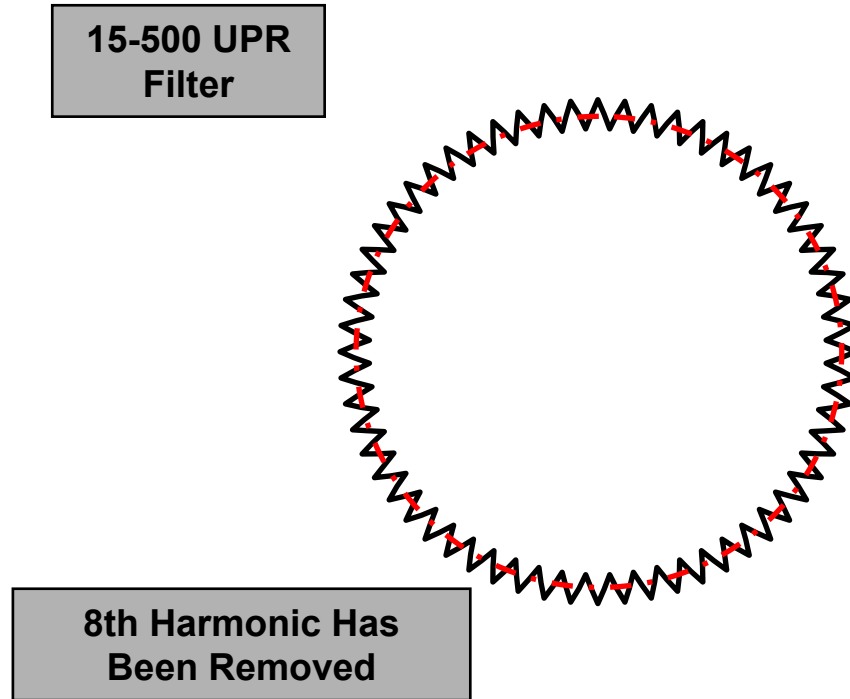

- Alternatively using a 15-500 filter suppresses anything below the 15th harmonic and anything above the 500th harmonic.
- In this instance the 60th harmonic is now apparent
- Filters therefore are an extremely useful tool to the analyst.
- They can also be open to misuse, it is important that when measuring and analysing roundness the correct filter type and value are specified, this is to prevent interpretation errors between supplier and purchaser.

2CR Filter – Early Electronic Filters

2CR = 2 Capacitors 2 Resistors

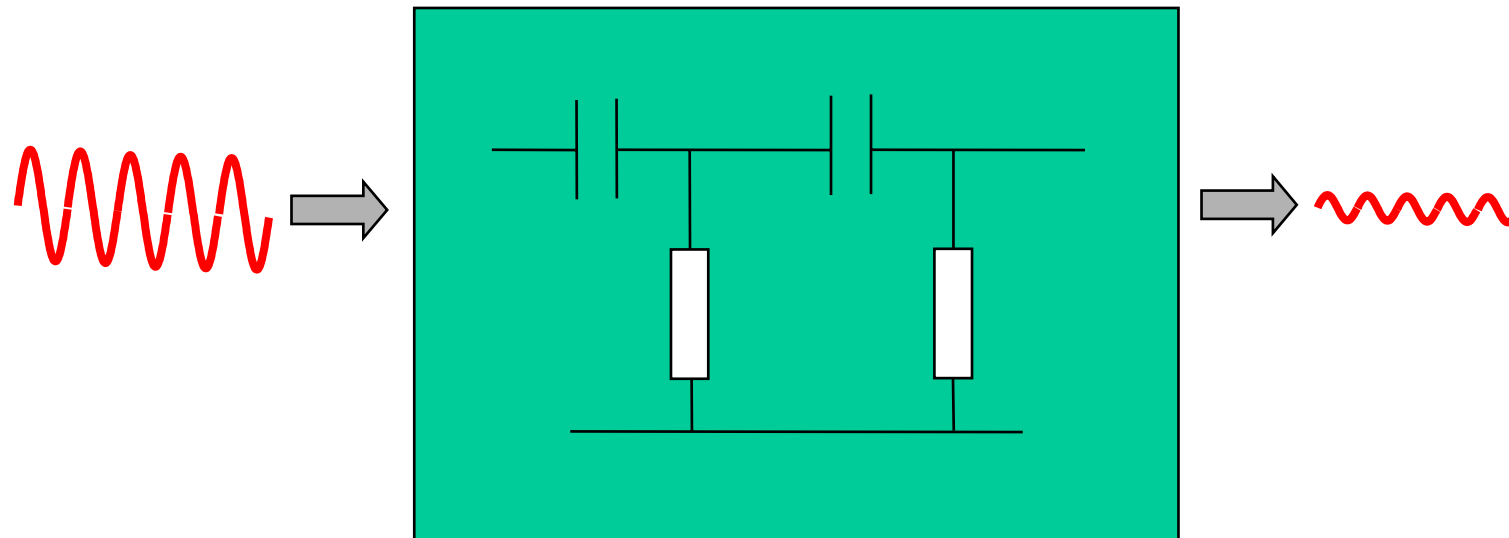

Reduces the Amplitude of the Harmonic at the selected UPR Value by 25%

- There are two basic types of filter, these are the Gaussian filter and the 2CR filter.
- The 2CR filter is an electronic filter and consists of two capacitors and two resistors hence the name 2CR

Characteristics of a 2CR Filter

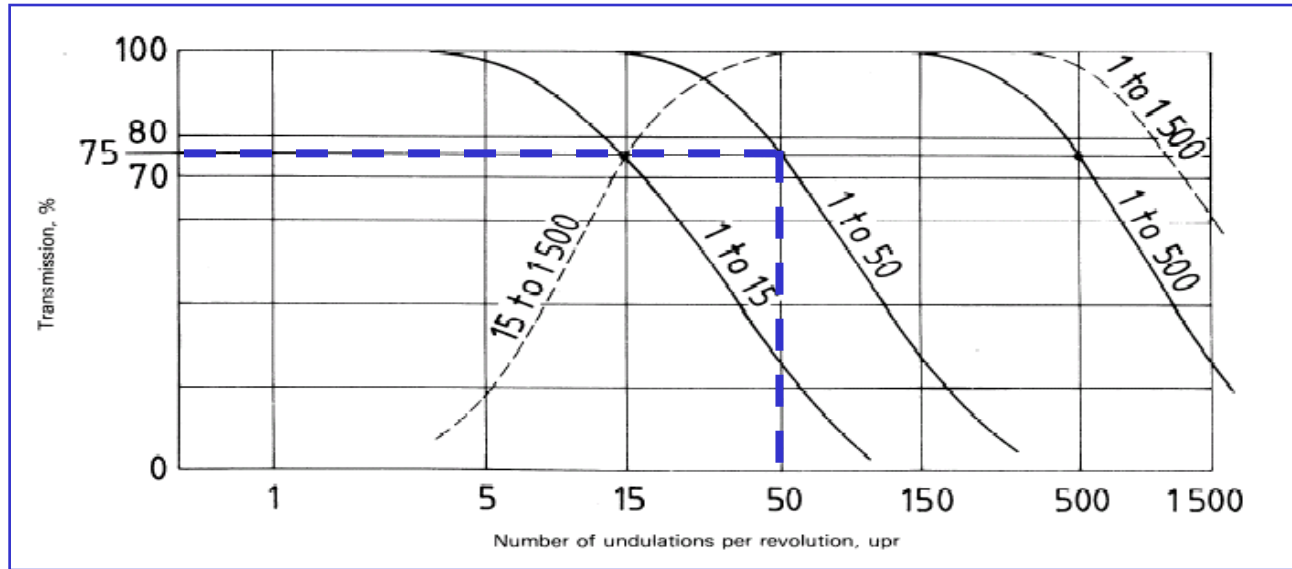

1-50 UPR Filter

- The above slide shows the transmission characteristics of a 2CR filter.
- This type of filter has the ability to attenuate the amplitude of the harmonic, at the selected UPR value, by 25%.
- As the harmonic value increases the greater the attenuation of the amplitude will be.
- For a 2CR filter the 50th harmonic shown above will be reduced in amplitude by 25%, the 51st will be reduced more and so on.

Characteristics of a 2CR Filter

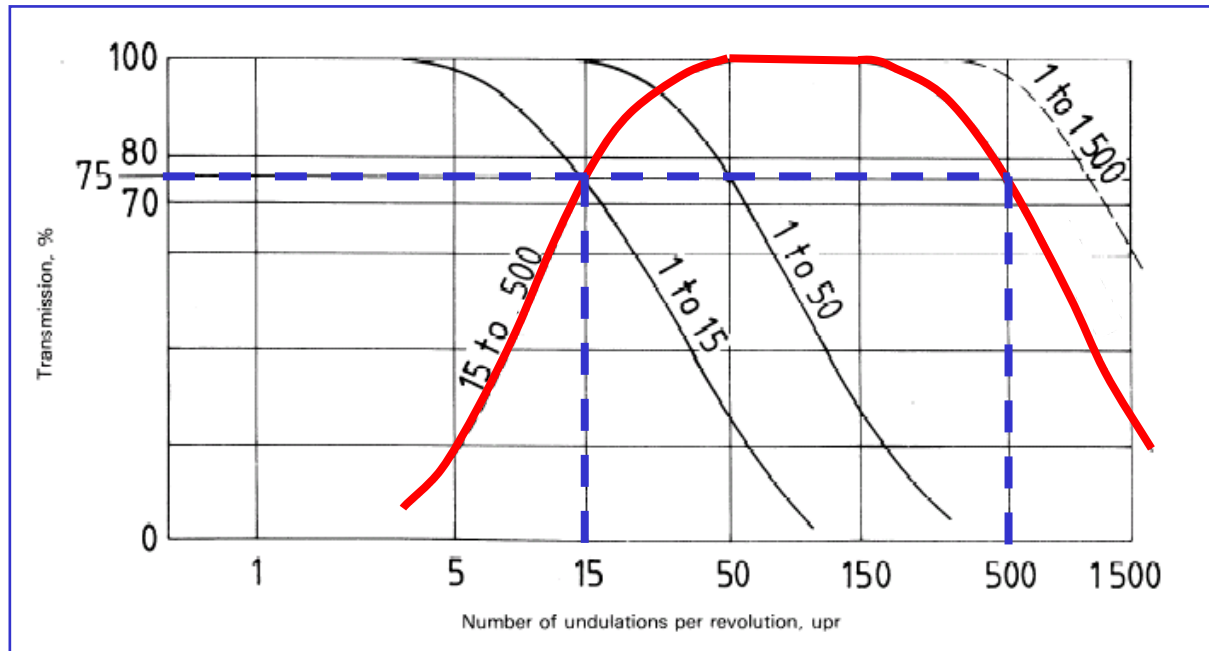

**15-500 UPR
Filter**

- When selecting a filter value of 15-500 UPR, the amplitude of the 15th and 500th harmonics will be attenuated by 25%.
- Harmonics outside of this range will be gradually attenuated as we move beyond the selected values.

Effects of a 2CR Filter

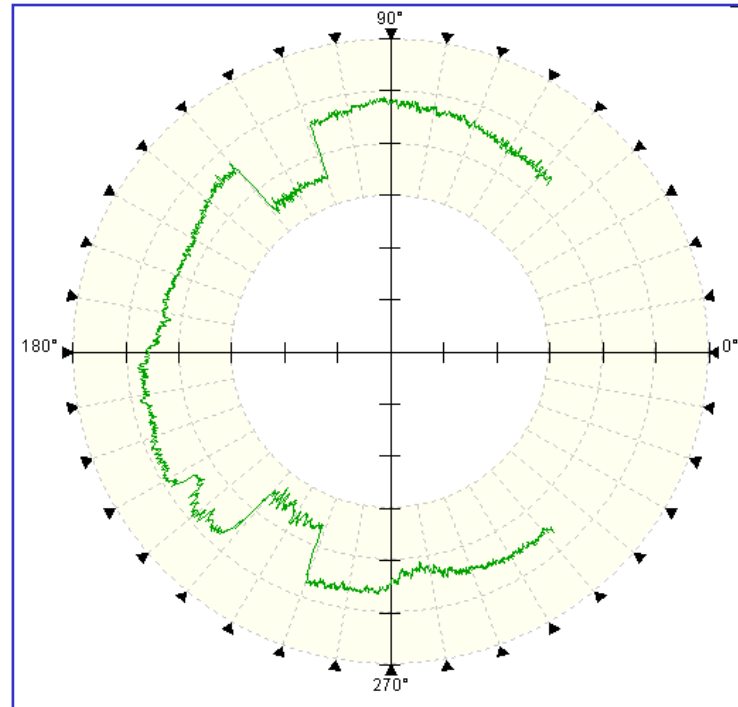

An Unfiltered Profile

- The above profile shows a roundness measurement of a part analysed without a filter, the profile has some large deviations in order to show the effects of using a filter.

Effects of a 2CR Filter

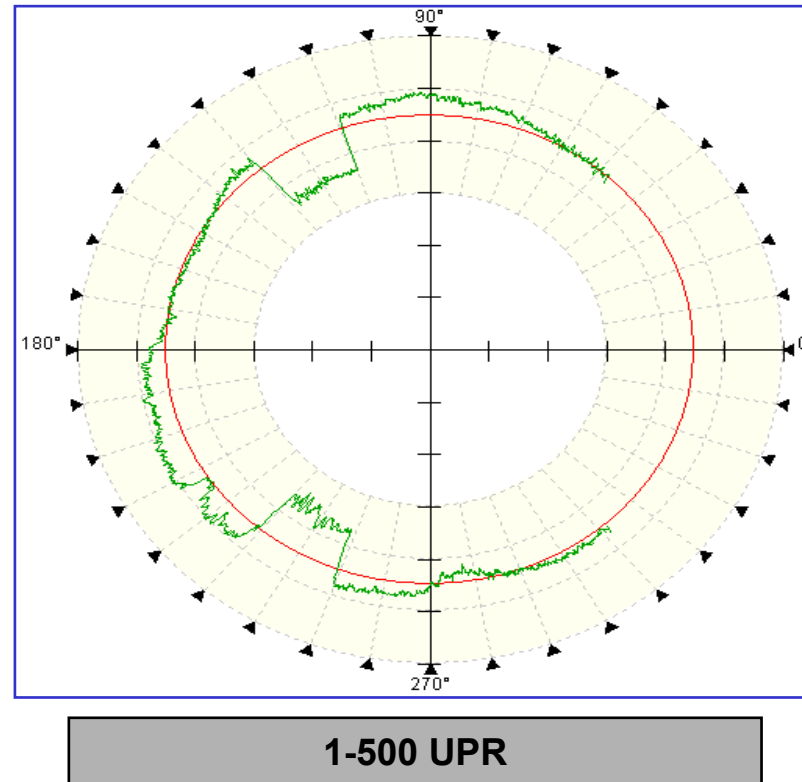

- The first filter selected has a value of 1-500 UPR, this allows higher values of harmonic to pass through the filter, these higher frequency harmonics can be seen on the plot above.

Effects of a 2CR Filter

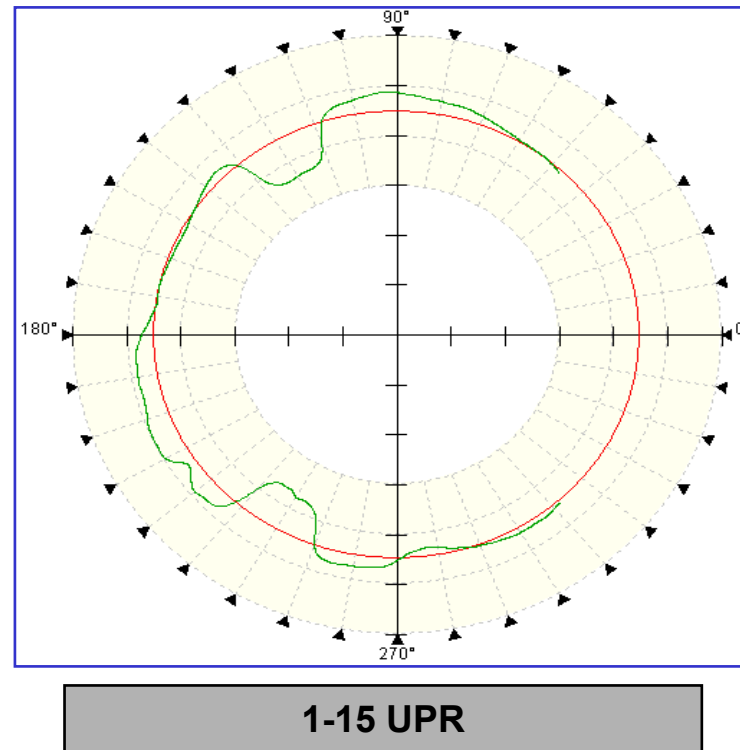

- The 1-15UPR filter has now had a drastic effect on the profile and not only has it removed high order harmonics there is a smoothing effect at the edges of the stepped areas of the roundness plot.

Gaussian Filter- Mathematical Filter

Gaussian = Filtering by applying a Mathematical Equation

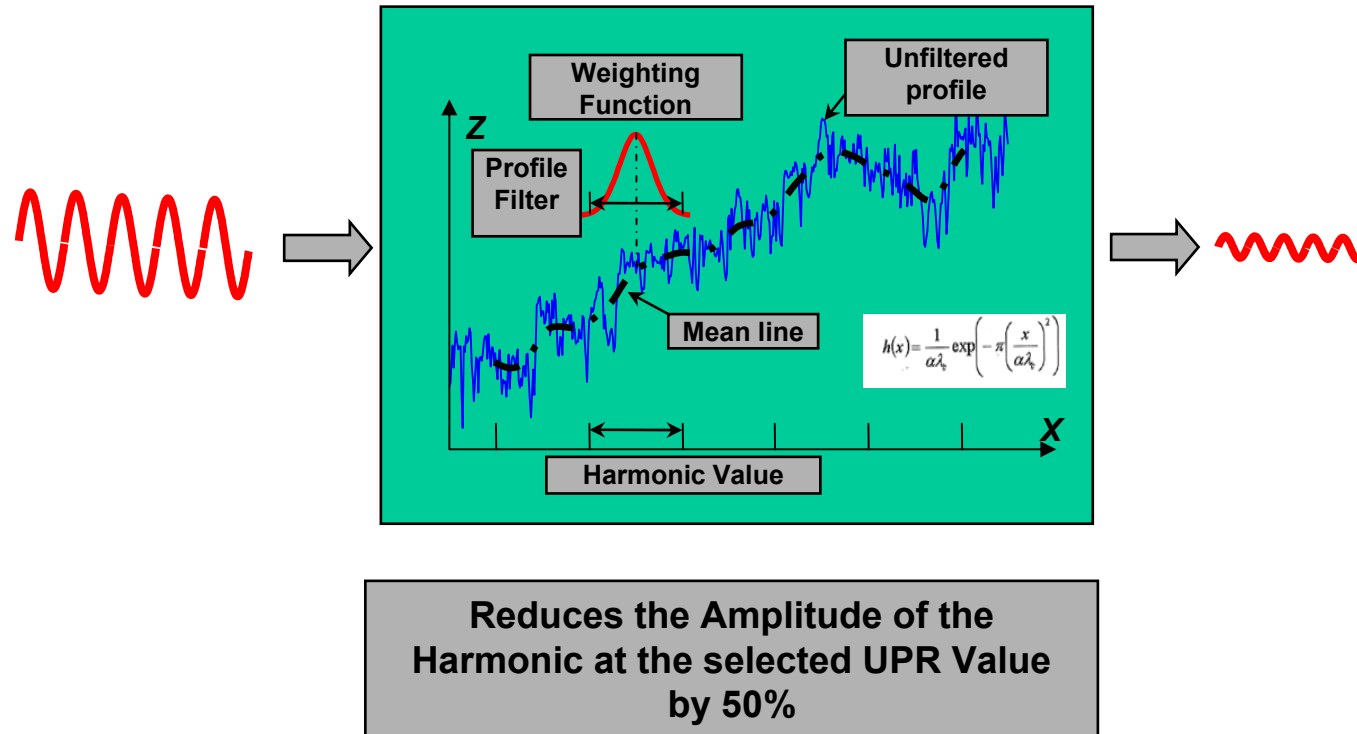

- The Gaussian filter is a mathematical filter.
- A property of the Gaussian Filter is the ability to take equal account of data before and after the effective stylus tip position when calculating the mean line. Which means it is phase corrected.
- The cut-off value (UPR) is determined by the width of the Gaussian distribution curve.
- The response at the filter value selected is 50% of the maximum transmission within the band
- The weighting function in its simplest form is a window applied to the unfiltered profile.
- The output is simply the average value of the profile enclosed by the window.

Global Excellence in Metrology



Characteristics of a Gaussian Filter

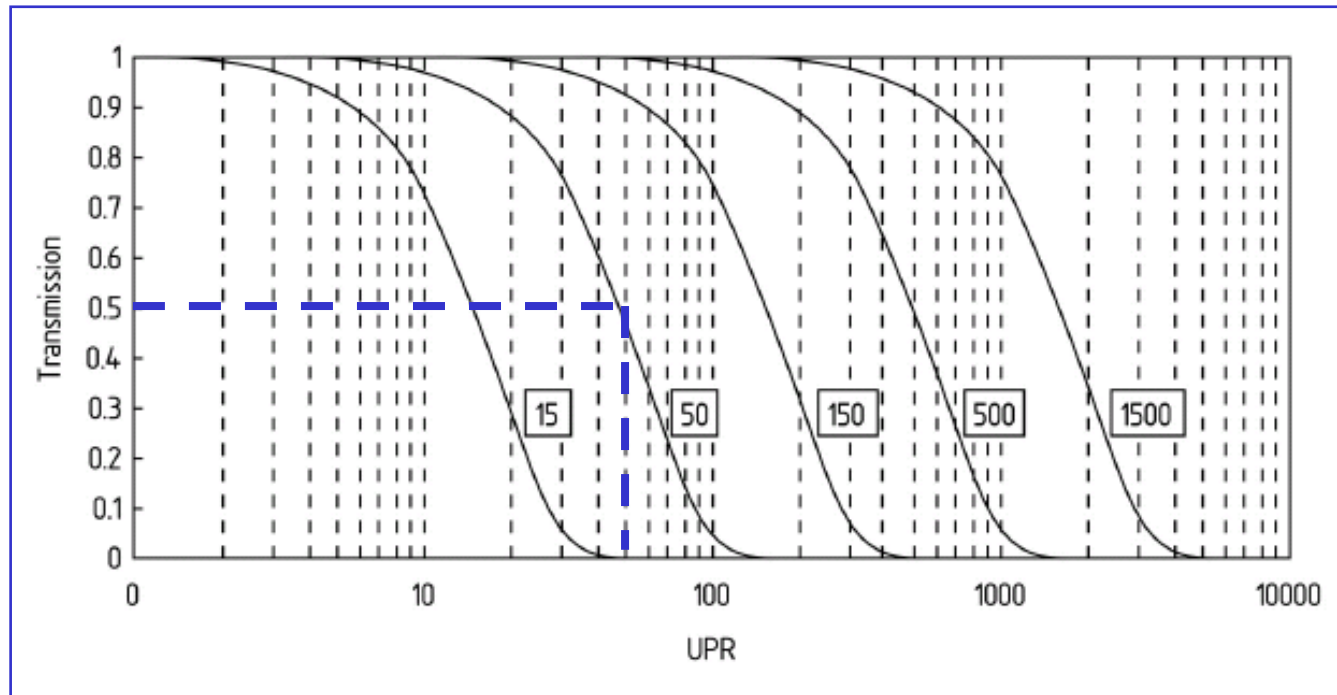

1-50 UPR Filter

- For a Gaussian filter the 50th harmonic will be reduced by 50% and the 51st harmonic will be reduced more on an ever increasing scale.
- It can be said therefore that the Gaussian filter has a greater response than the 2CR and on certain components this sharper cut-off point will usually give a difference in result.
- Distortion of the profile after filtering is less significant than a 2CR filter, due to the Gaussian filter's phase corrected characteristics.
- Therefore, this type of filter is the ISO recommended filter for roundness analysis.

Characteristics of a Gaussian Filter

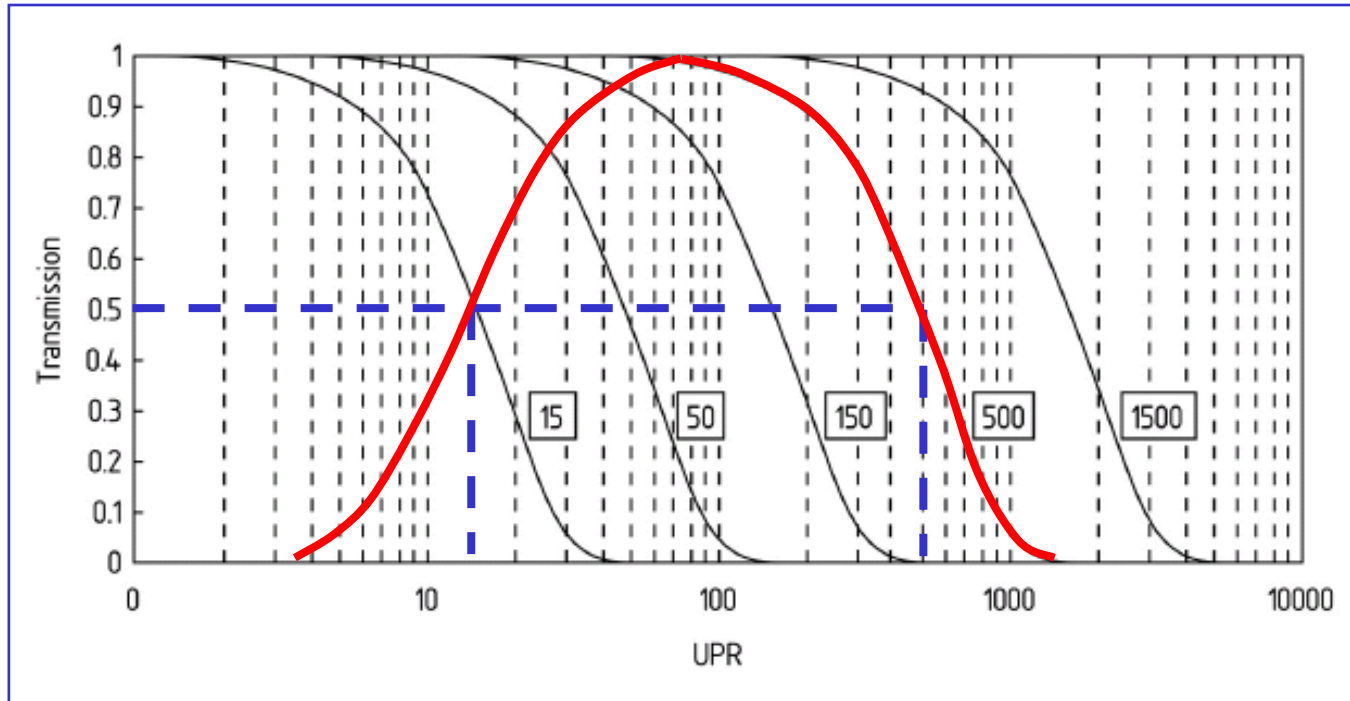

15-500 UPR Filter

- In the above example both the 15th harmonic and the 500th harmonic will be reduced in amplitude by 50%.
- Harmonics less than the 15th and greater than the 500th will be decreased by a greater percentage as they progress further away from the selected 15-500UPR filter band.

Comparison of 2CR to Gaussian Filter

The Gaussian Filter

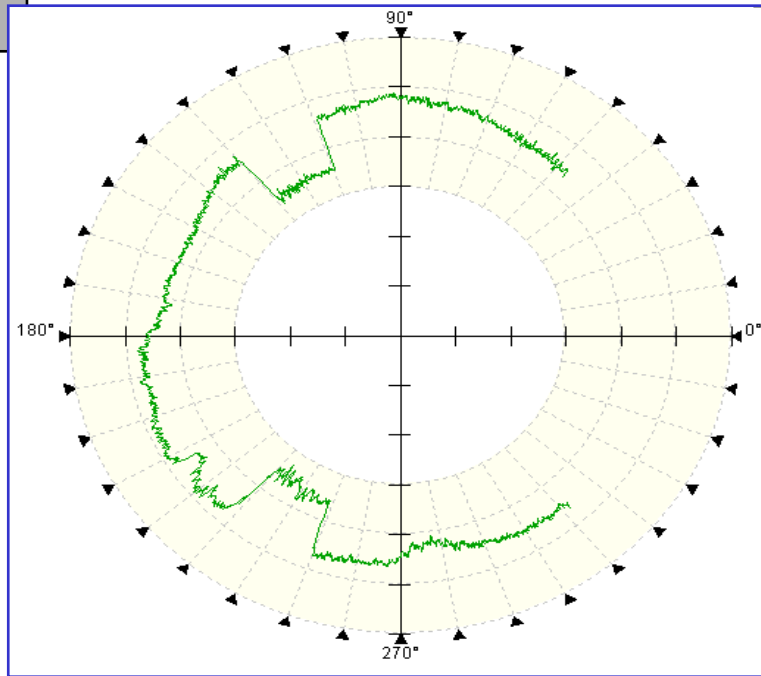

Unfiltered Profile

This time we can see the effect of using a Gaussian filter on the same component.

Comparison of 2CR to Gaussian Filter

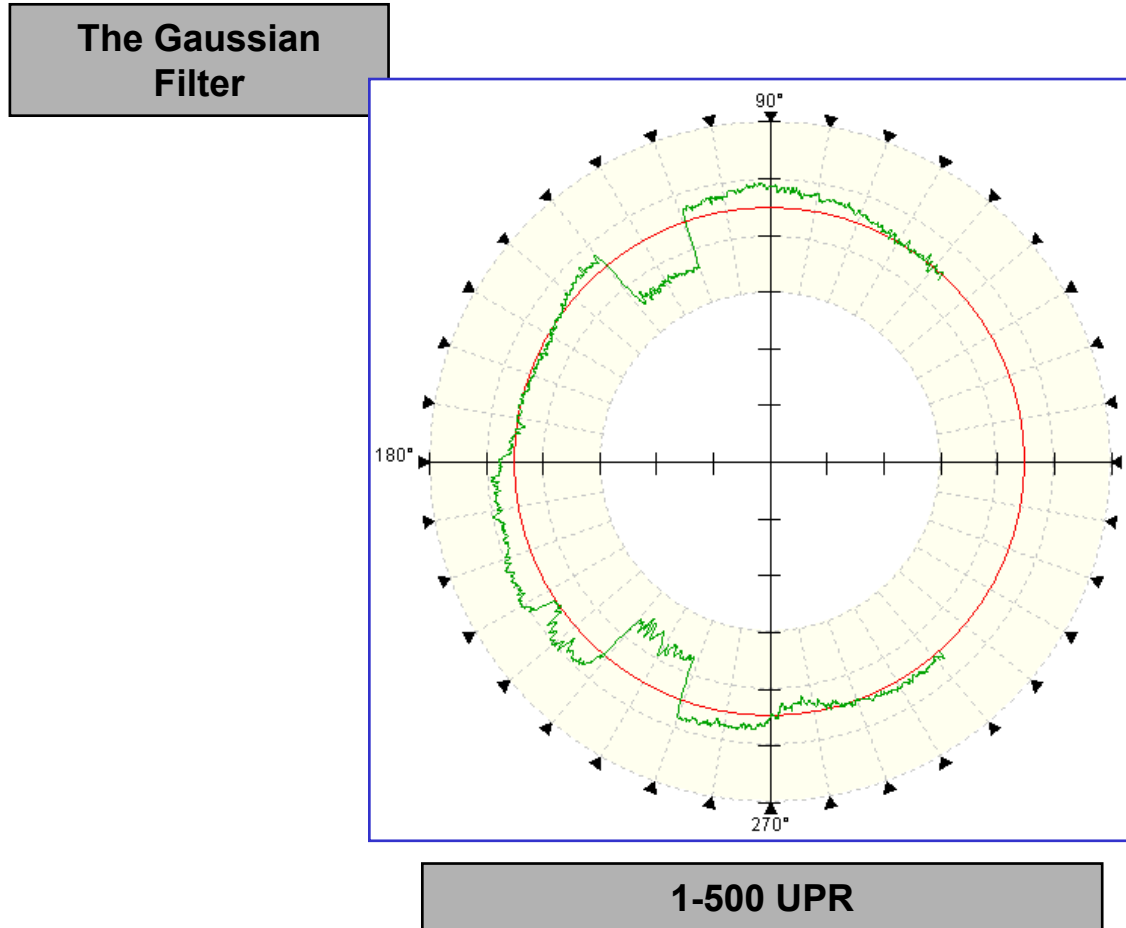

Results obtained when using a 1-500 upr filter.

Global Excellence in Metrology

 TAYLOR HOBSON®

AMETEK®
ULTRA PRECISION TECHNOLOGIES

Comparison of 2CR to Gaussian Filter

The Gaussian Filter

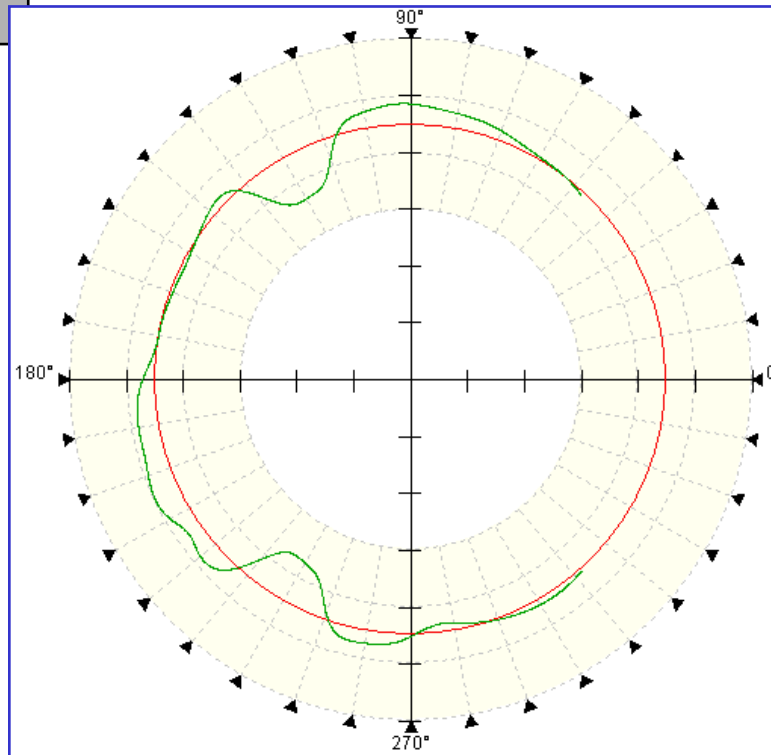

1-15 UPR

Result obtained when using a 1-15 upr filter.

Global Excellence in Metrology

 TAYLOR HOBSON®

 **AMETEK**®
ULTRA PRECISION TECHNOLOGIES

Comparison of 2CR to Gaussian Filter

Comparison of the Gaussian Filter and 2CR Filter

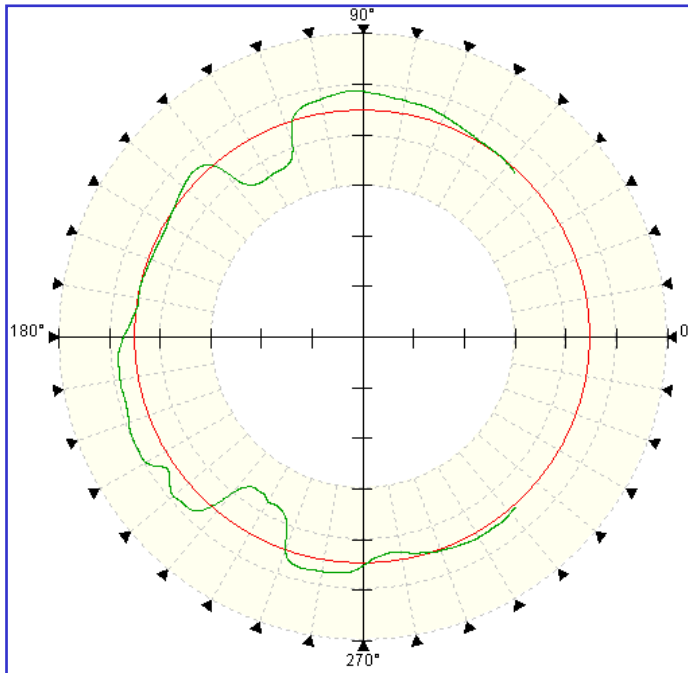

1-15 UPR 2CR Filter

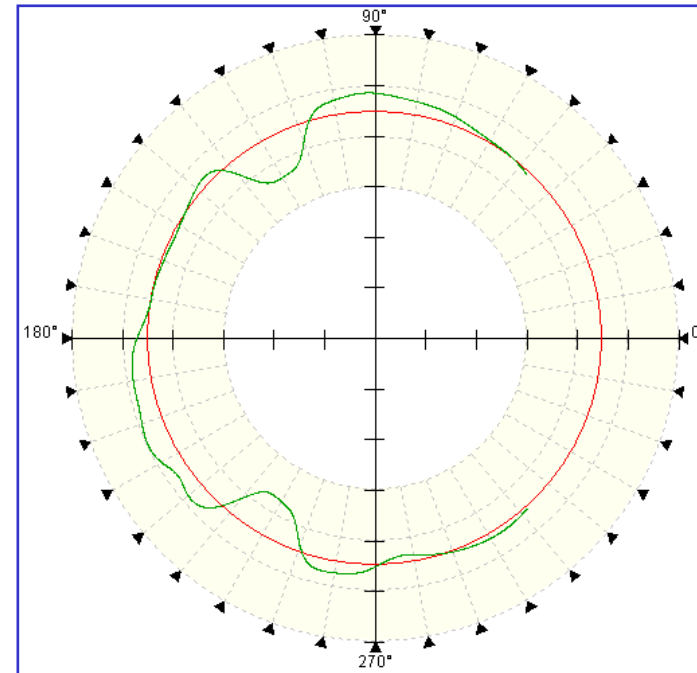

1-15 UPR Gaussian Filter

- Looking at the two profiles above it is possible to see the greater effect of the Gaussian filter as opposed to the 2CR.
- The Gaussian plot shows a smoother plot than the 2CR and has had a greater effect on higher frequencies.

Filters - Stylus Tip Diameter

Tip Diameter Must Be Considered When Selecting Filters

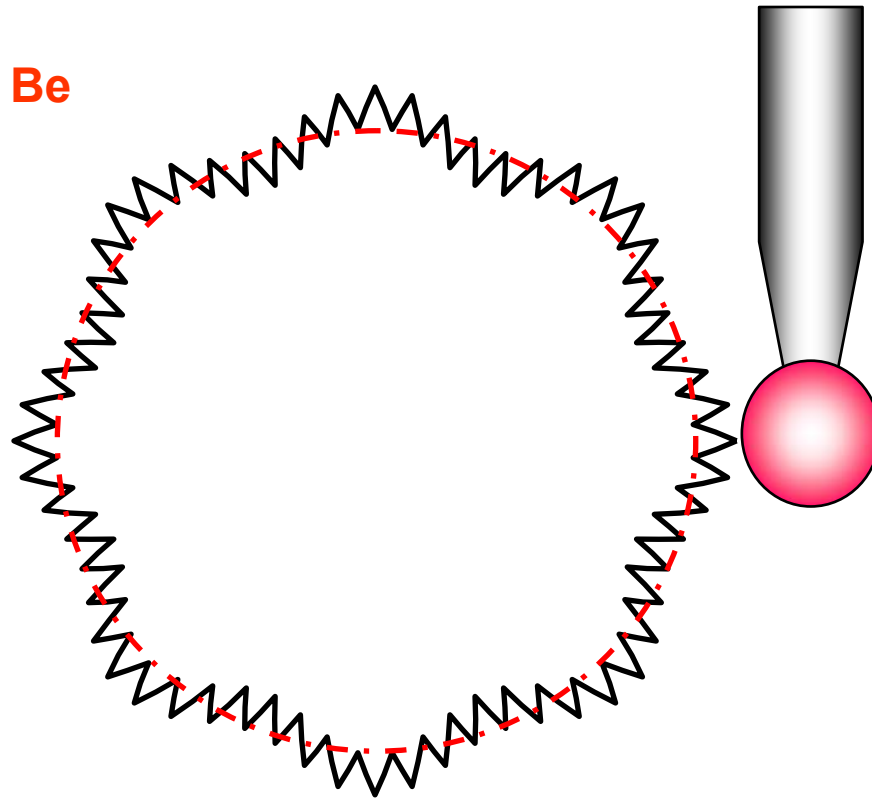

- The stylus tip diameter should also be taken into consideration when selecting filters.
- A large diameter stylus tip will have a greater mechanical filtering effect than a smaller diameter tip.
- The size of the component will also have an effect, the smaller the ratio of component diameter to stylus diameter the greater the filter effect.
- Remember this effect will be more apparent on peaks than troughs.

Tip Diameter Selection / Filter Selection

Part Diameter (mm)	Circumferential Filter Cut-off (UPR)
$D \leq 8$	1-15
$8 < D \leq 25$	1-50
$25 < D \leq 80$	1-150
$80 < D \leq 250$	1-500
$250 < D$	1-1500

The above table shows the recommended filter to use according to component size (ISO 12180-2)

- There is a direct relationship between the stylus tip diameter, the component diameter, and the recommended filter to use.
- In the above table, we can see the recommended filter to use according to the size of the component's diameter.
- In practice, the filter is chosen according to the way the component is to be used.

Filter Selection

$$\text{UPR} = \frac{\pi d}{0.8}$$

Where: d = Part Diameter

The formula shows the recommended filter to use according to component size (ISO 12181-2)

- For a more precise selection of a UPR filter value the above formula may be used.
- The diameter of a part has a direct influence on the value of UPR present on the circumference of a component. Therefore it is more sensible to select a filter value that corresponds to the component diameter.
- It is envisaged that in future releases of the ISO standards that the above formula will be the default for filter selection.

Tip Diameter Selection

$$R = \frac{\pi d}{24}$$

Where: R = Stylus Tip Radius
d = Part Diameter

See ISO 12180-2 for further information

- The recommended stylus tip is 0.5mm radius or 1mm diameter for components larger than 4mm in diameter, however when the component diameter becomes quite small then the stylus tip diameter will need to be reduced.
- The formula above shows a calculation of the stylus tip when the diameter of the component becomes less than 4mm.
- Remember that the filter used would be 1-15 when used with this calculation (see previous page), if a harmonic content greater than 15UPR was required then smaller styli would have to be considered.
- For more information please consult ISO/DIS 12180 - 2:1998

Harmonic Analysis

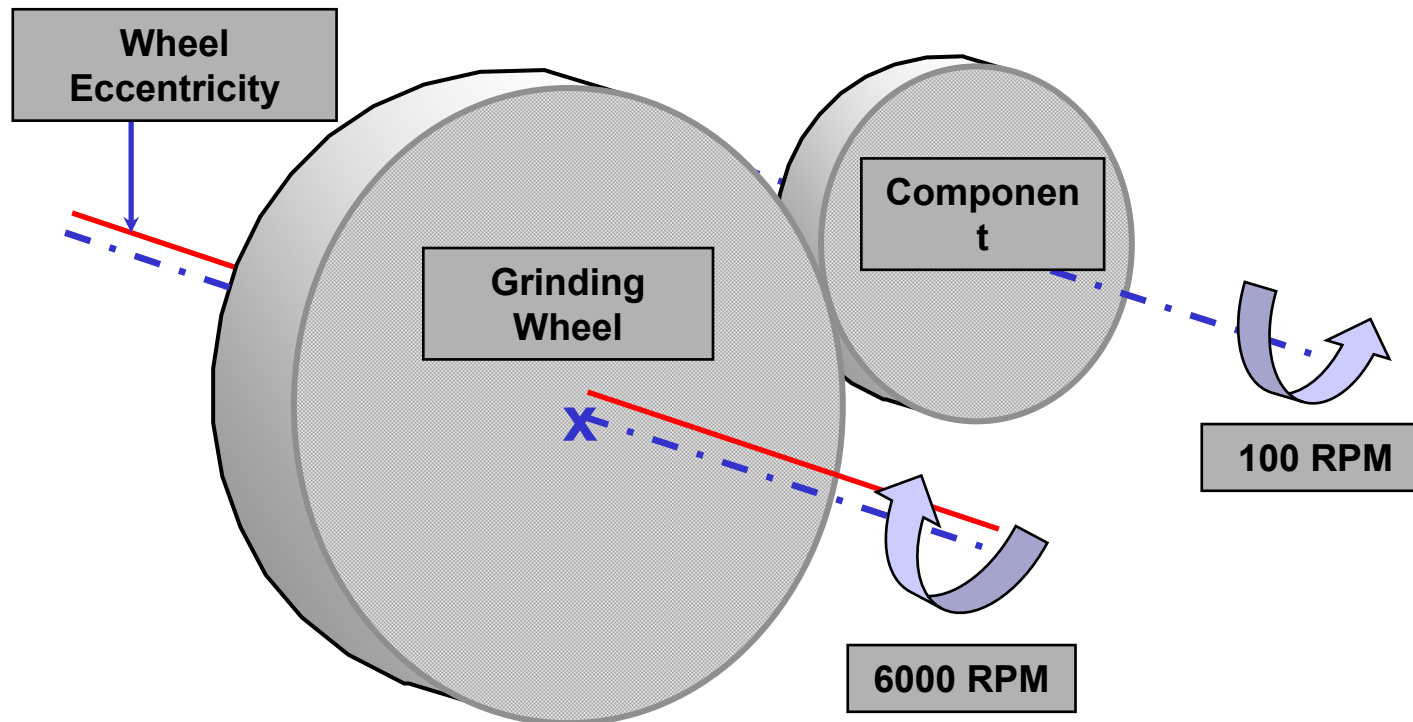

- The ability to breakdown the analysed part into individual harmonics can be extremely useful.
- The example above shows a grinding wheel and a component.
- Because the grinding wheel is moving at 6000RPM and the Component is moving at 100RPM the speed ratio is 60:1, this means that for every one revolution of the component the grinding wheel has revolved 60.
- If there is an eccentricity of the grinding wheel then this will induce an in and out movement of the wheel relative to the component, this will induce a 60th harmonic on the component.

Harmonic Analysis

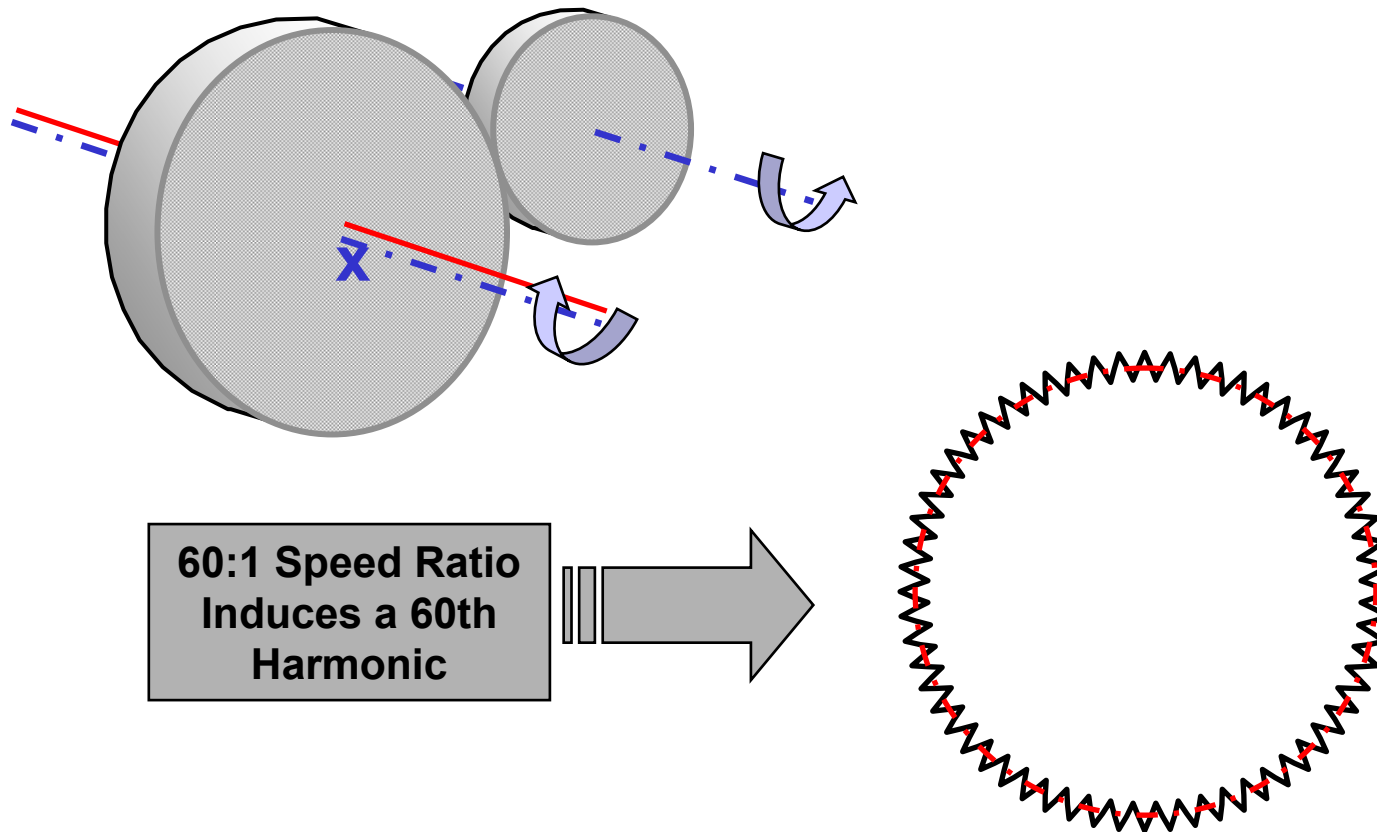

- From the picture above we can see the 60th harmonic on the measurement of the component.
- We can see that the results appear as peaks and valleys on the part, initial reaction is to say that these valleys cannot be produced by a large grinding wheel. In actual fact what appear as valleys are actual small concave almost flat like areas, this effect is because of distortion due to magnification.

Harmonic Analysis

1st Harmonic - Function of Measurement

Measurement Set-up Error

2nd Harmonic - Function of Measurement or Manufacture

Measurement Set-up Error or Machined out of Square

3rd to 7th Harmonic - Function of Manufacture

Workpiece Holding Method

7th to 15th Harmonic - Function of Manufacture

Instability of the Machining Process

15th Harmonic Upwards - Function of Material & Manufacture

Reaction of Materials, Machine Chatter

By analysing the Harmonics of a component it is possible to control both the performance of the part and the manufacturing process. The Harmonics produced are a combination of component geometry, material and method of manufacture. In general the Harmonics produced can be grouped together as follows:

- 1st Harmonic - Function of Measurement**, caused only by the setting up error of the part on the roundness instrument. The amplitude of this Harmonic is equal to the eccentricity of the part axis to the instrument spindle axis.
- 2nd Harmonic - Function of Measurement or Manufacture**, Generally called ovality, caused either by setting up error of the part on the roundness instrument or the part being machined out of square to its axis of rotation.
- 3rd to 7th Harmonic - Function of Manufacture**, these Harmonics are usually caused by the method of holding the part during manufacture. E.g tri-lobed profile caused by excessive clamping in a 3 jaw chuck.
- 7th to 15th Harmonic - Function of Manufacture**, Harmonics in this range are generally caused by the method of manufacture and the instability of the machining process.
- 15th Harmonic Upwards - Function of Material & Manufacture**, usually caused by either instability of the manufacturing machine (e.g. chatter) or by the reaction of the materials used in the component, cutting tool and lubricant.

Global Excellence in Metrology



Harmonics Amplitude Display

Harmonics		Harmonic Table : HAR/Gaussian/1-50upr					30/08/02 11:12:36			
		exercise 3 : 360°/Admin/exercice 3.PLN					18/01/01 11:34:08			
Harmonic Amplitude (μm)										
UPR	N+0	N+1	N+2	N+3	N+4	N+5	N+6	N+7	N+8	N+9
0		0.43	0.16	0.55						

RONt 1.54 μm , Ecc 0.43 μm , Conc 0.85 μm

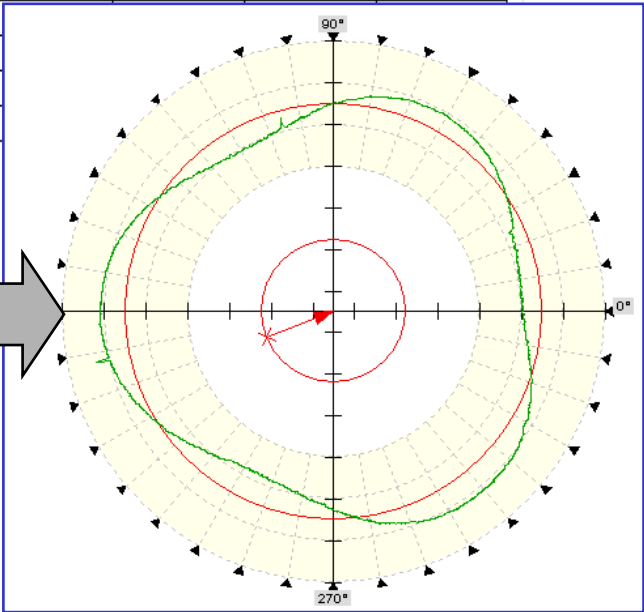

The harmonic table displays the amplitude of each harmonic number. In this example the 1st harmonic (N+1) is 0.43 μm , this value is the eccentricity of the component with respect to the datum (spindle) axis, in other words the measurement set up error. The concentricity is double the 1st harmonic amplitude, i.e. 0.85 μm . The dominant 3rd harmonic (N+3) gives a tri-lobed shape on the profile. This would indicate a possible problem with over tightening of the work piece during the machining process.

Harmonics Histogram Display

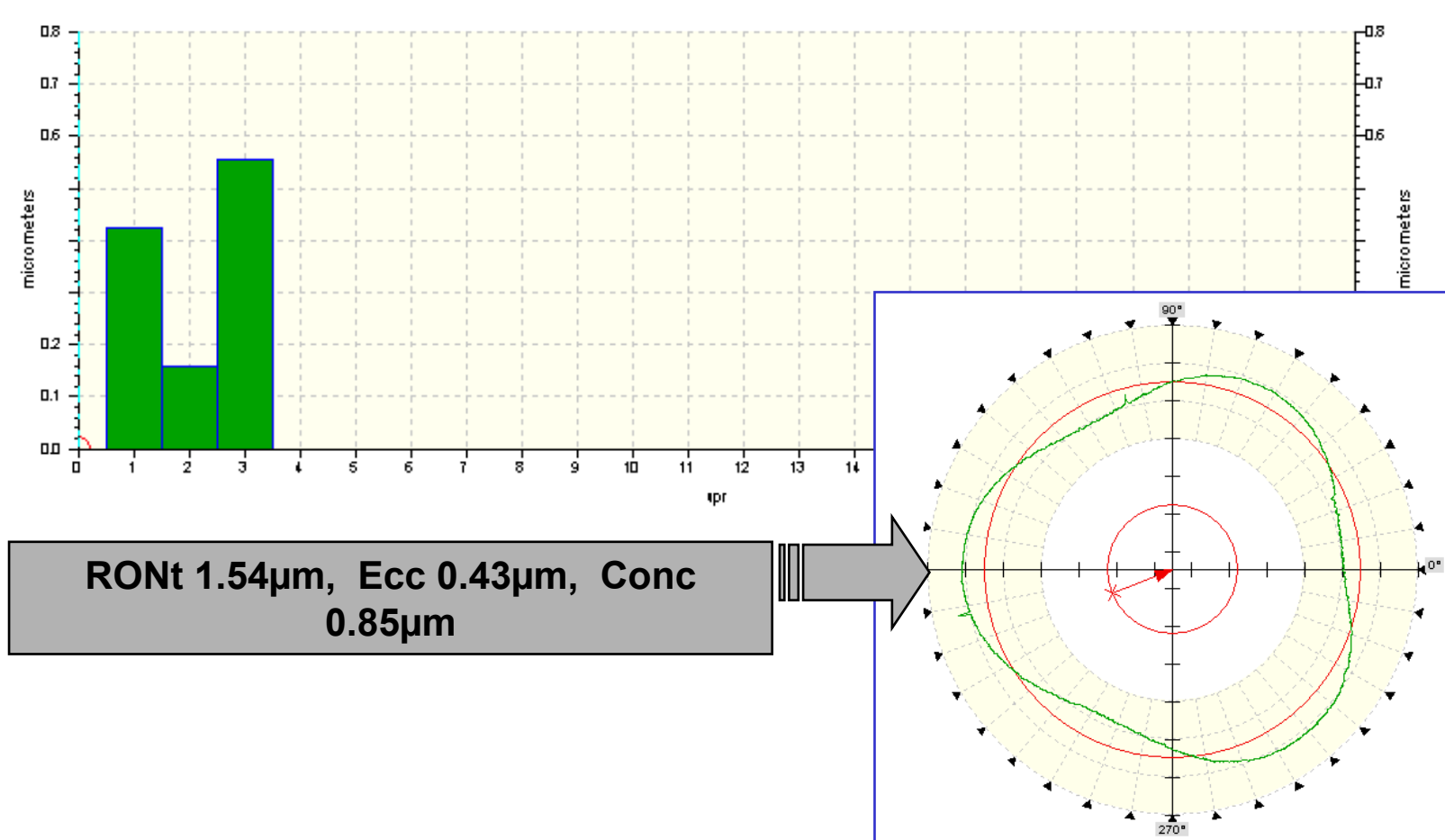

- The harmonic histogram displays the amplitude of each harmonic number.
- This gives the operator a more obvious visualization of the dominant harmonics within the selected filter band.

Harmonic Analysis

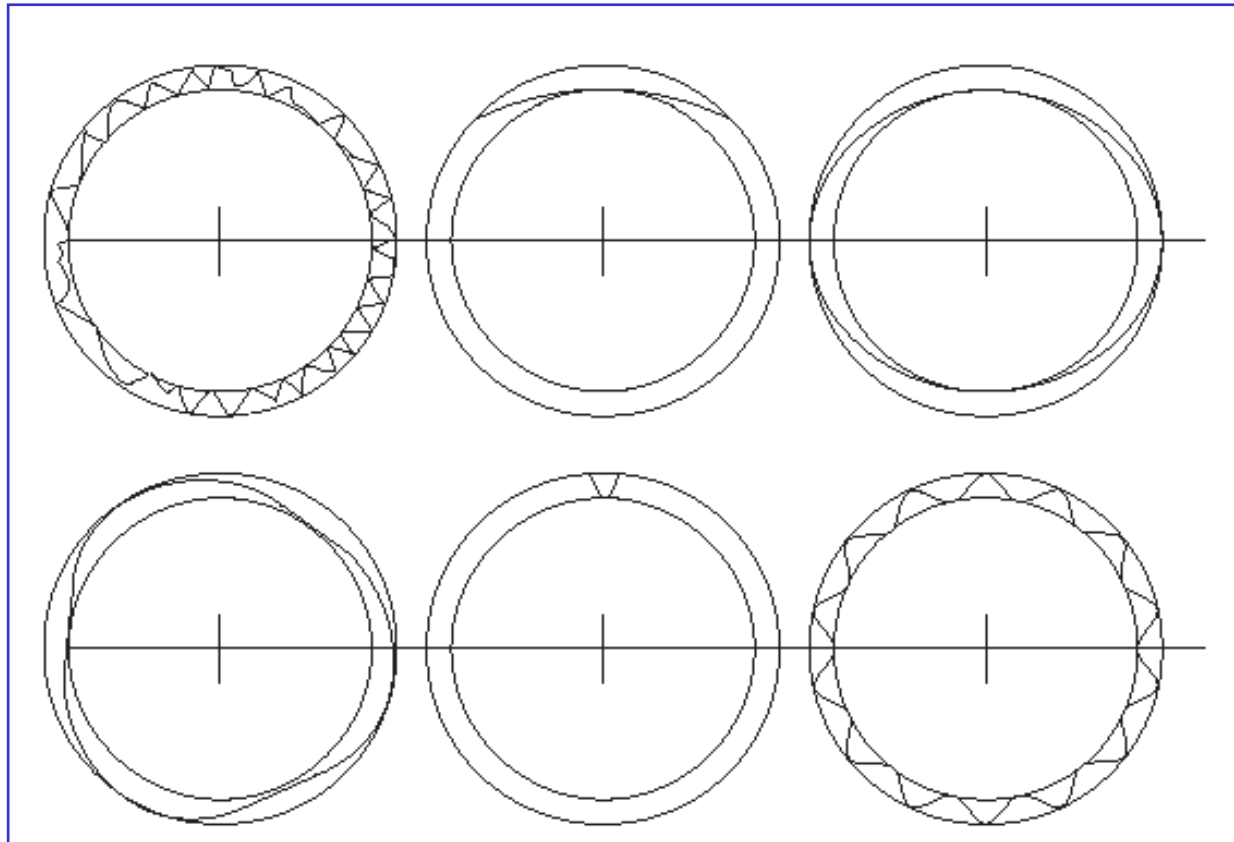

Different Profiles - Identical Roundness

Using harmonic analysis allows the operator to distinguish between profiles with the same overall roundness, yet with different surface profiles.

Summary

What are Harmonics

- Harmonics are wavelengths contained on the manufactured surface .
- The Harmonics produced are a combination of component geometry, material and method of manufacture

Filters

- Two types of filter
- 2CR – Early Electronic Filter
- Gaussian – Current Mathematical Filter
- Both types isolate wavelengths on the surface.

Harmonic Analysis

- By analysing the Harmonics of a component it is possible to control both the performance of the part and the manufacturing process

Contact us

Material produced by Taylor Hobson Centre of Excellence

For more information contact:

email: taylor-hobson.cofe@ametek.com

or call: +44 116 276 3779

Centre of Excellence Services

For calibration, training and precision metrology beyond the scope of your business expertise, the Taylor Hobson Centre of Excellence has experienced professional metrologists along with state of the art measuring instruments.

Metrology Training Courses

We offer standard and bespoke Training Courses in Surface Finish and Roundness, coupled with contact and non-contact Instrument Operator Training. To improve the understanding and application of Roundness and Surface Finish principles by your operators, inspectors and engineers.

Instrument Training

Without question, the benefits of training are exponentially greater than the cost. When your operators, inspectors and engineers are well versed in the theory and application of metrology they are more confident, more efficient, better informed and more likely to avoid mistakes or misrepresentation of results.

Technical Support

Manned by a team of Experienced Metrologist's, we provide a Case Study or Measurement Report Service alongside a Contract Measurement Service, to help in the correct selection of our metrology systems.

Global Excellence in Metrology



AMETEK[®]
ULTRA PRECISION TECHNOLOGIES