

Composite True Position

Pic. 7-43

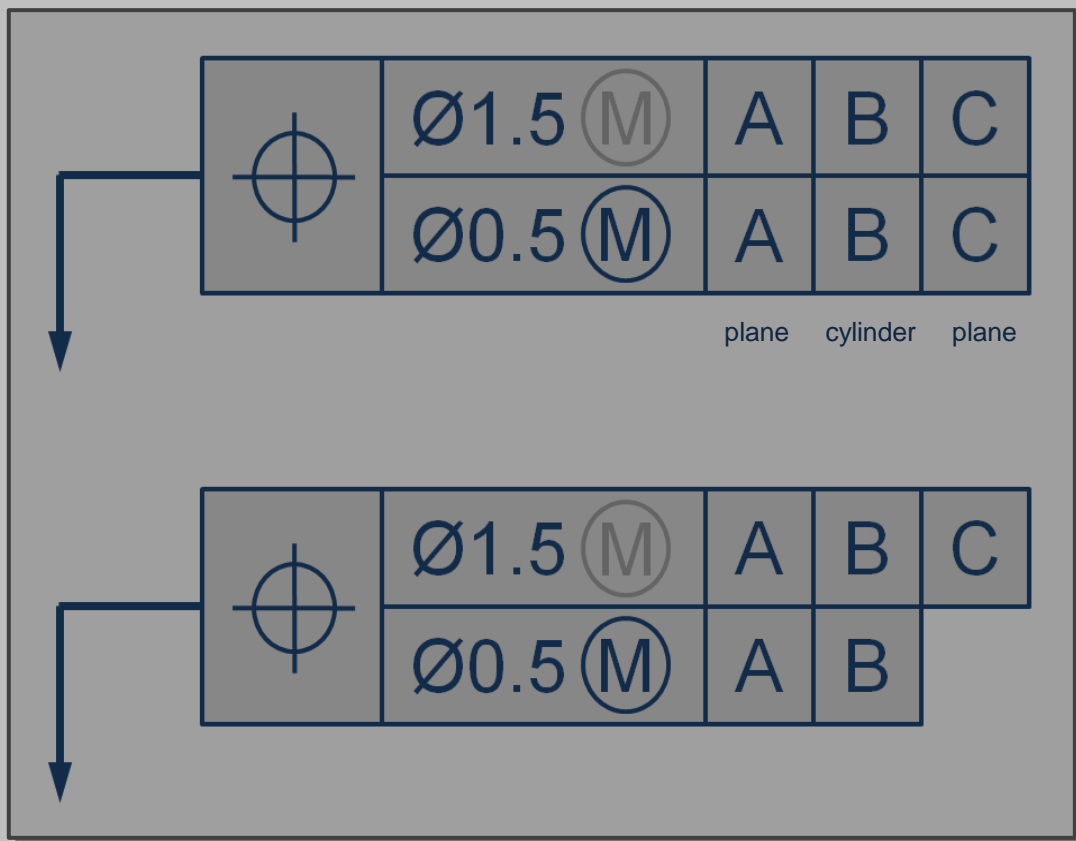

Composite True Position

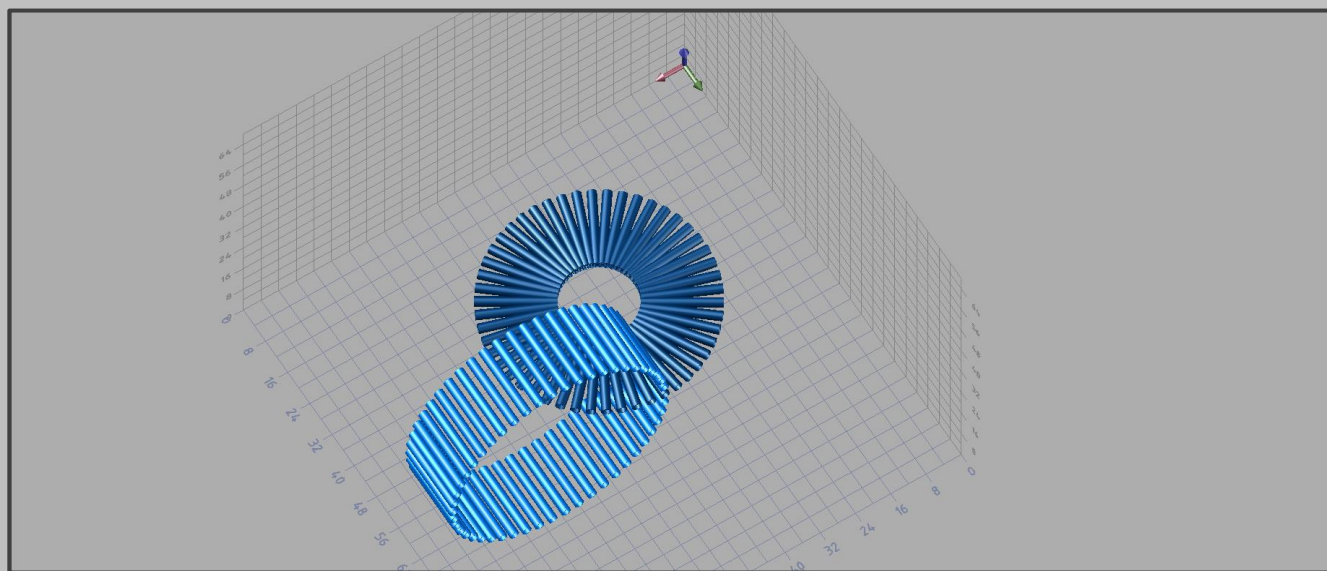
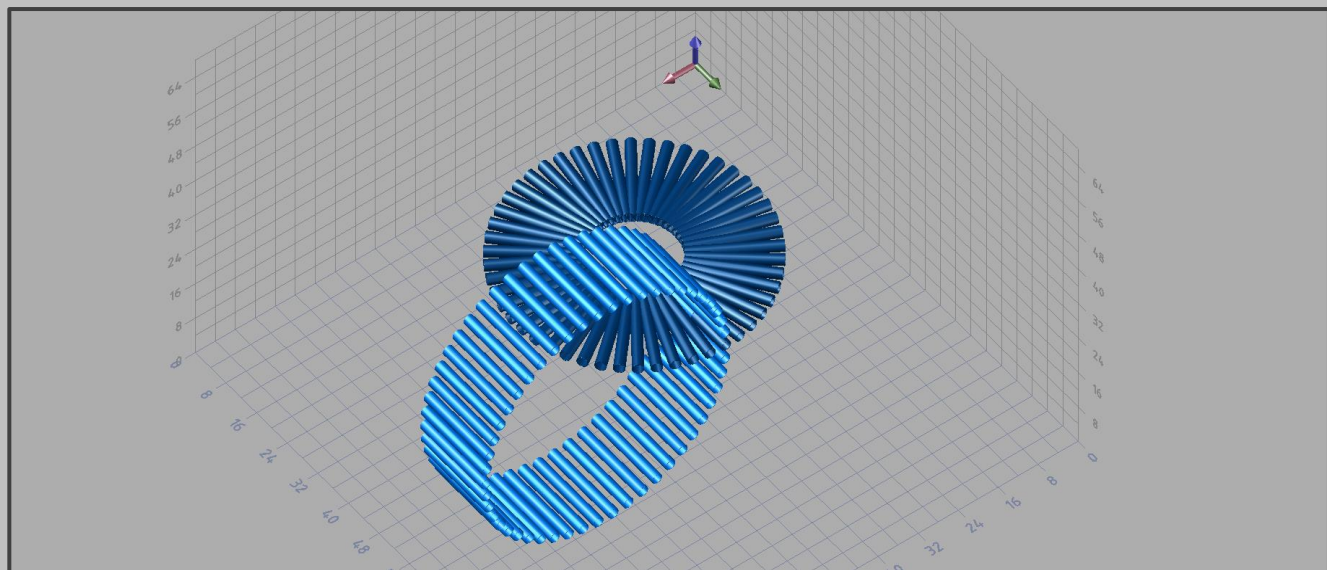
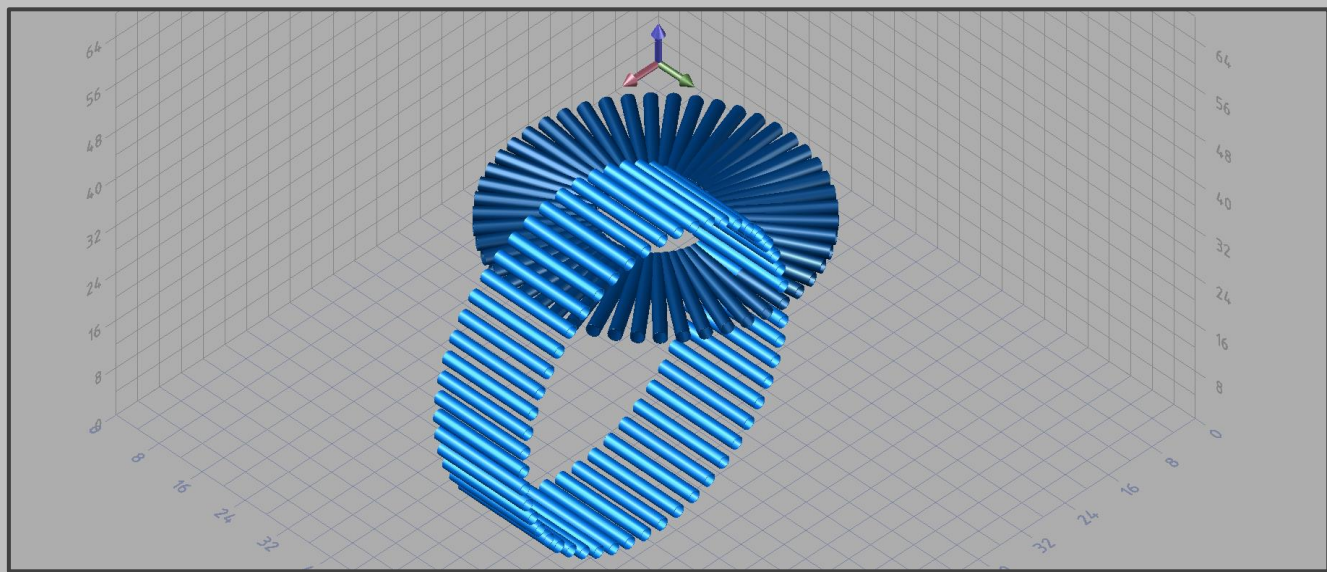

Composite True Position

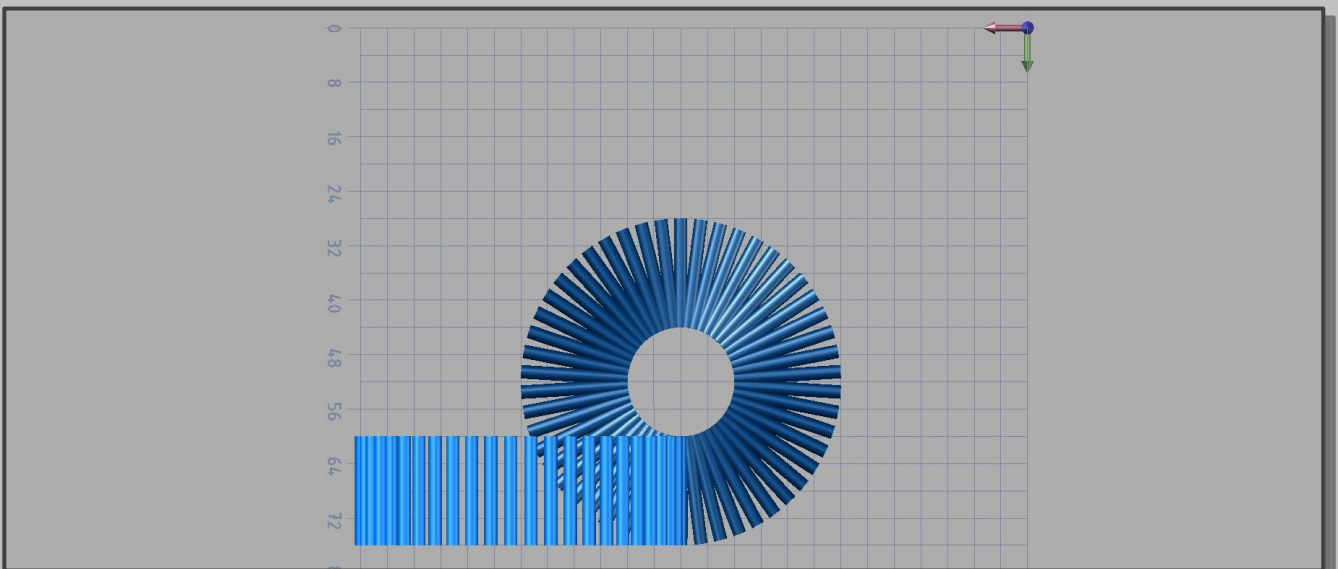
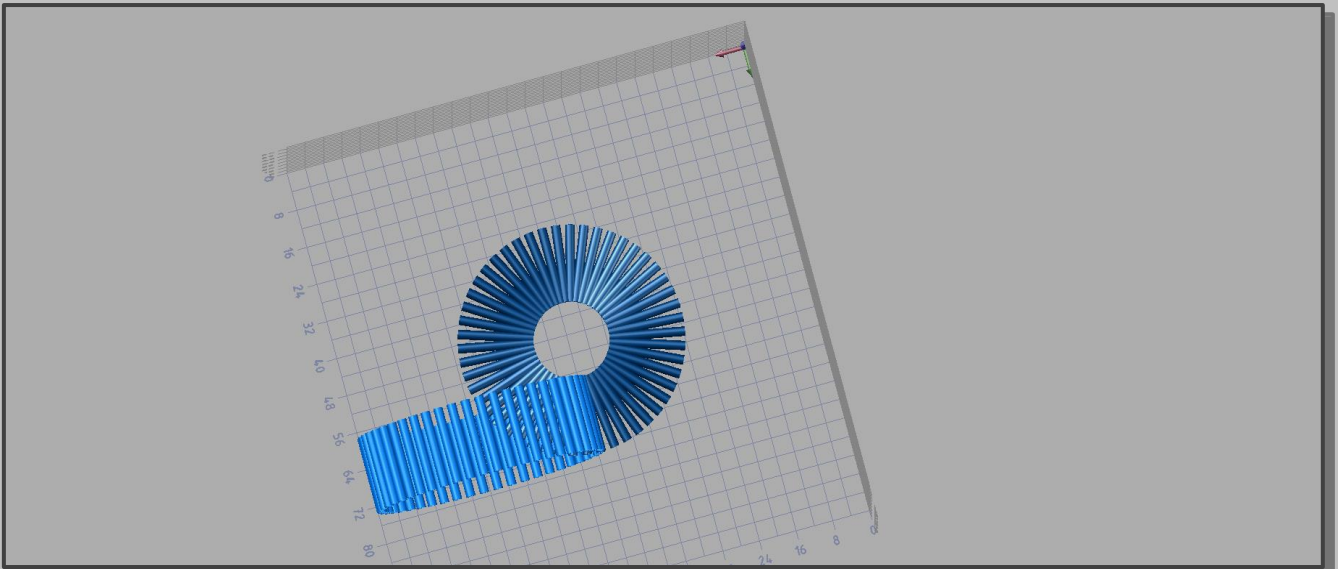
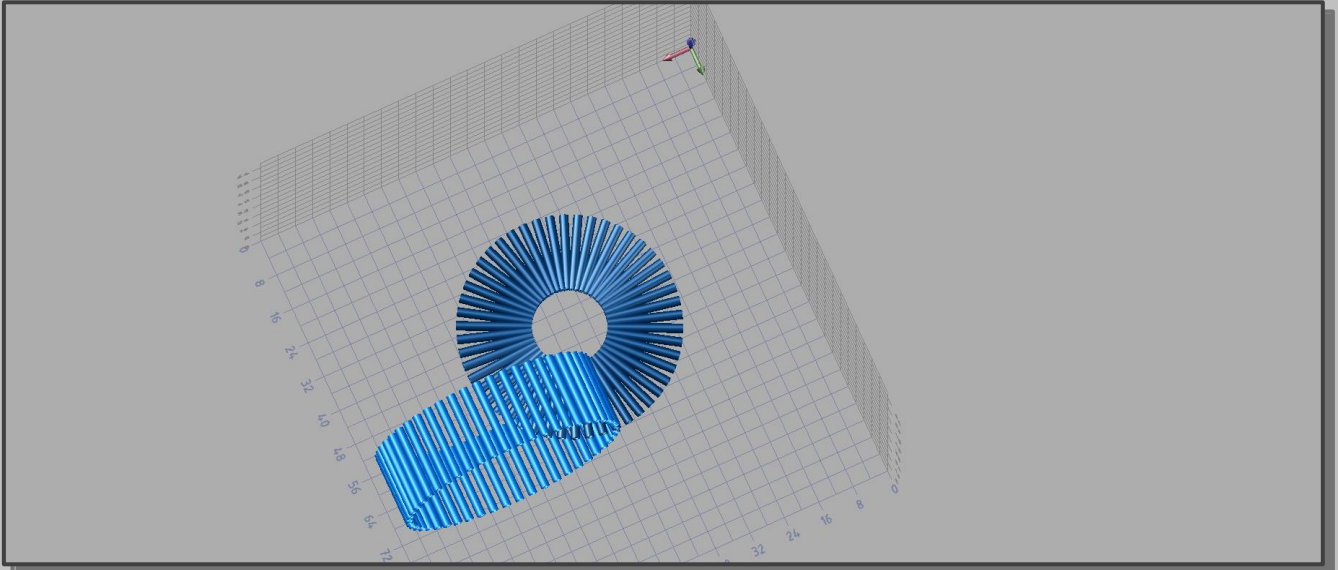

Composite True Position

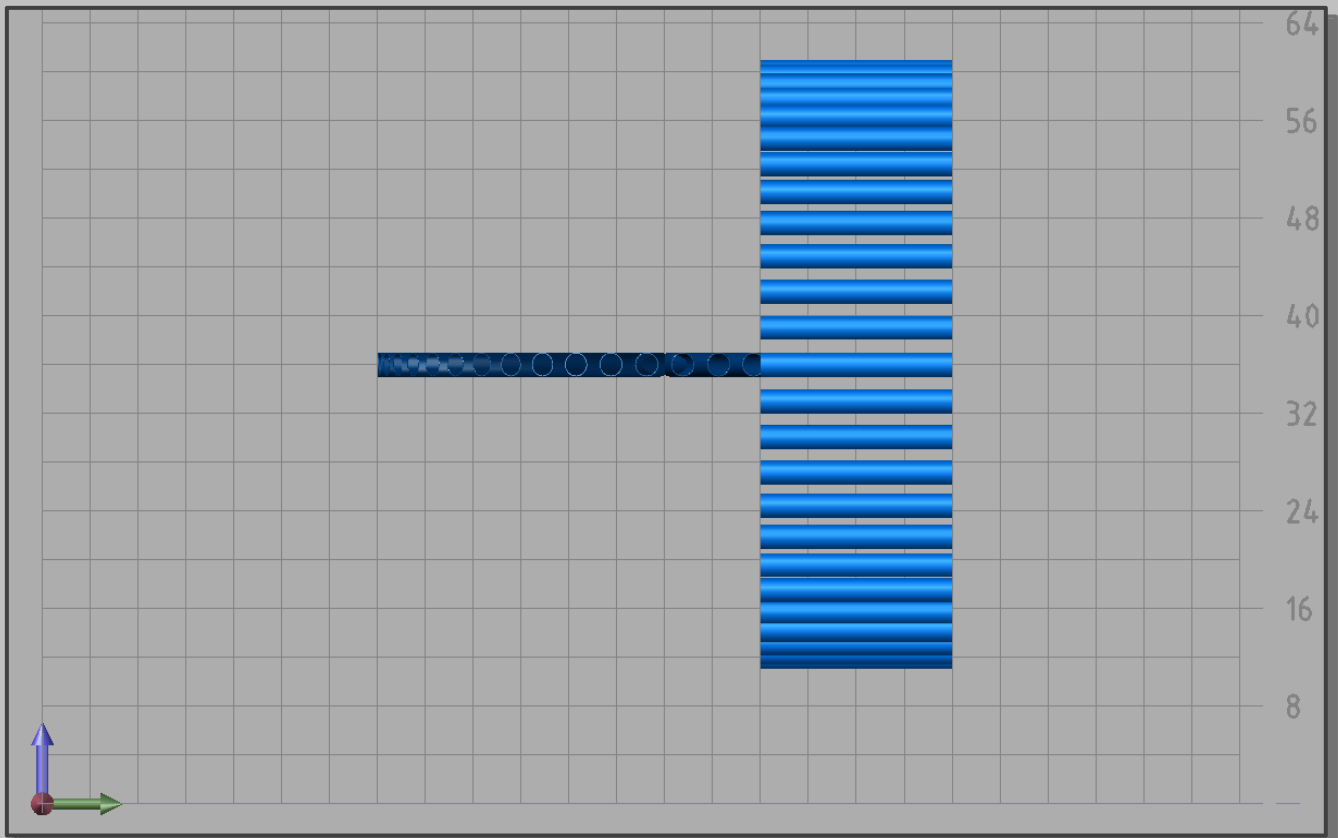
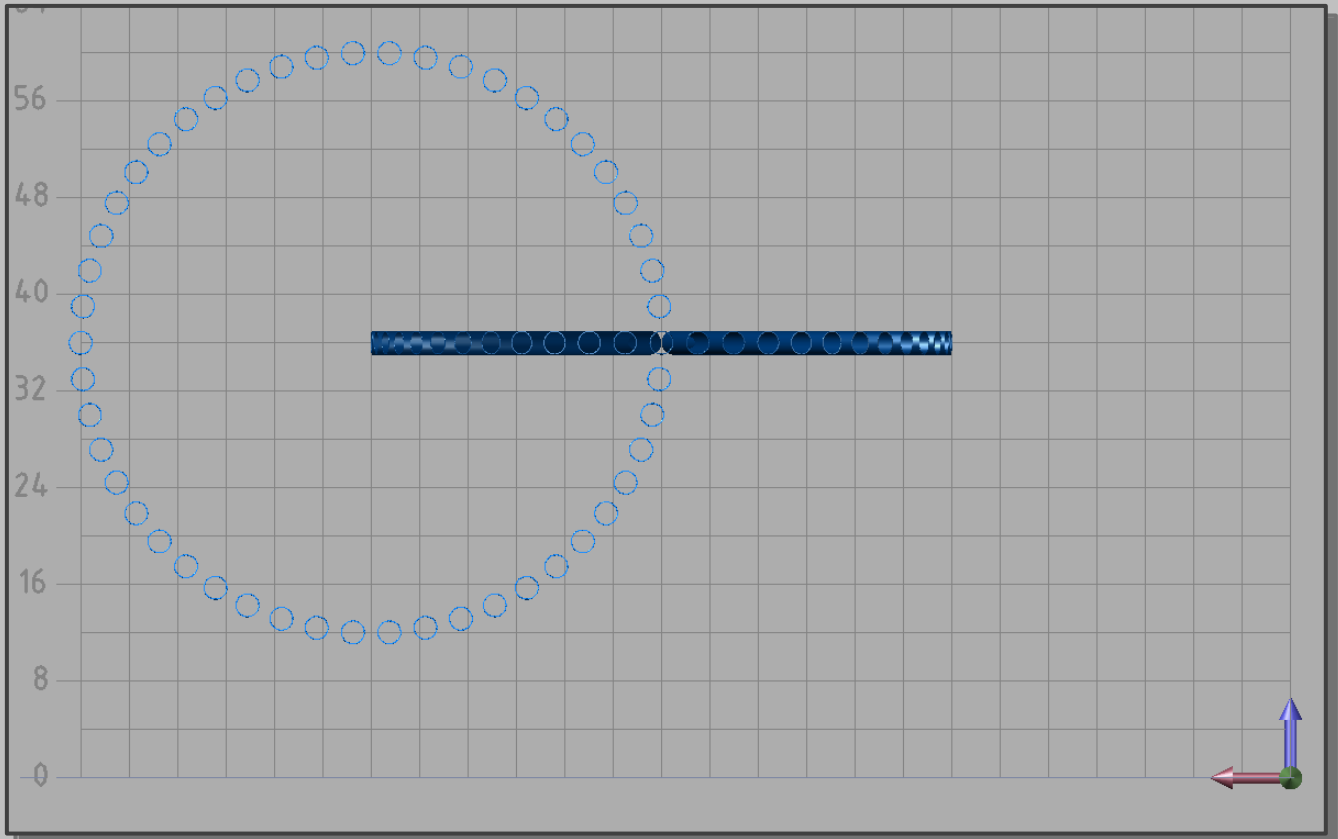

Composite True Position

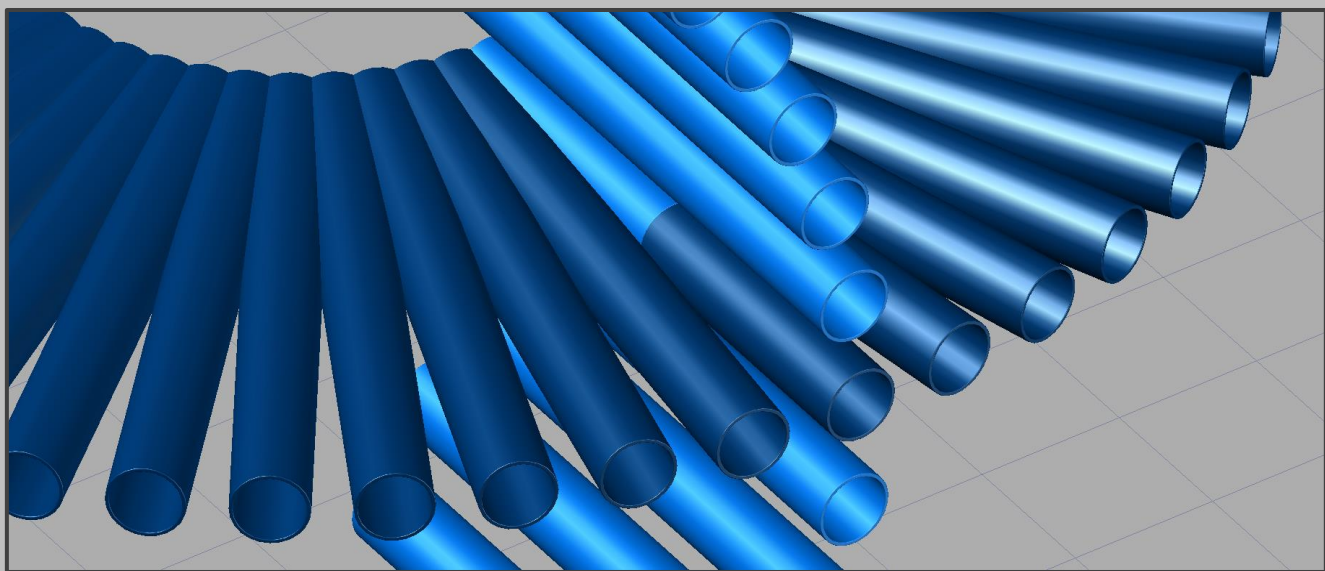
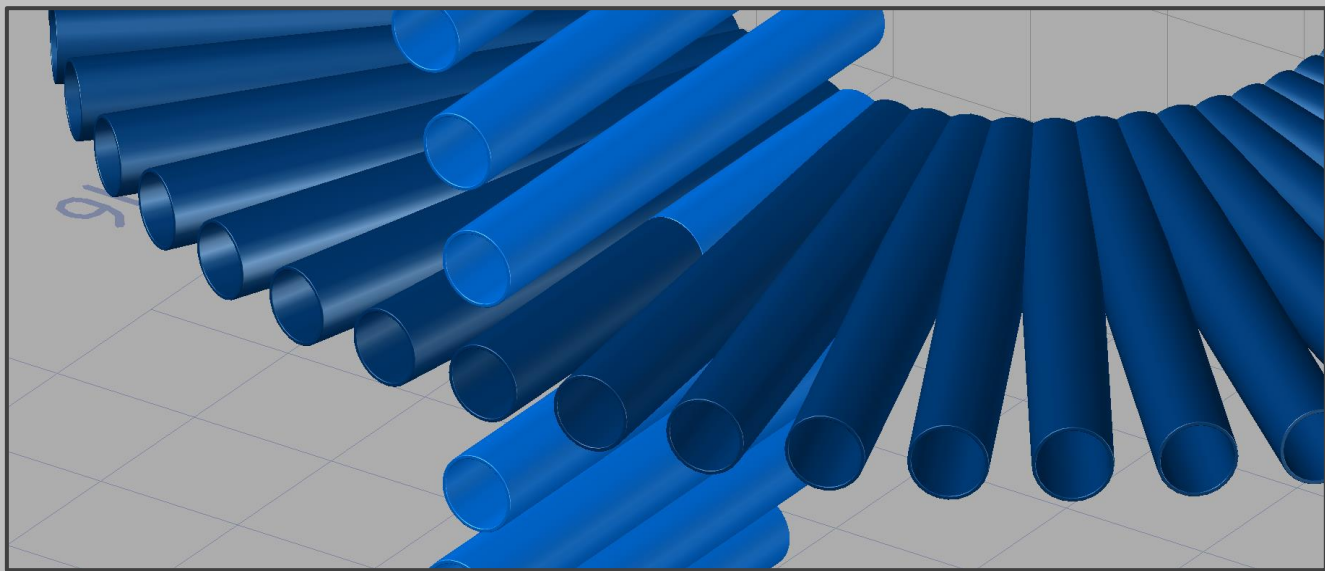

Composite True Position

FRTZF

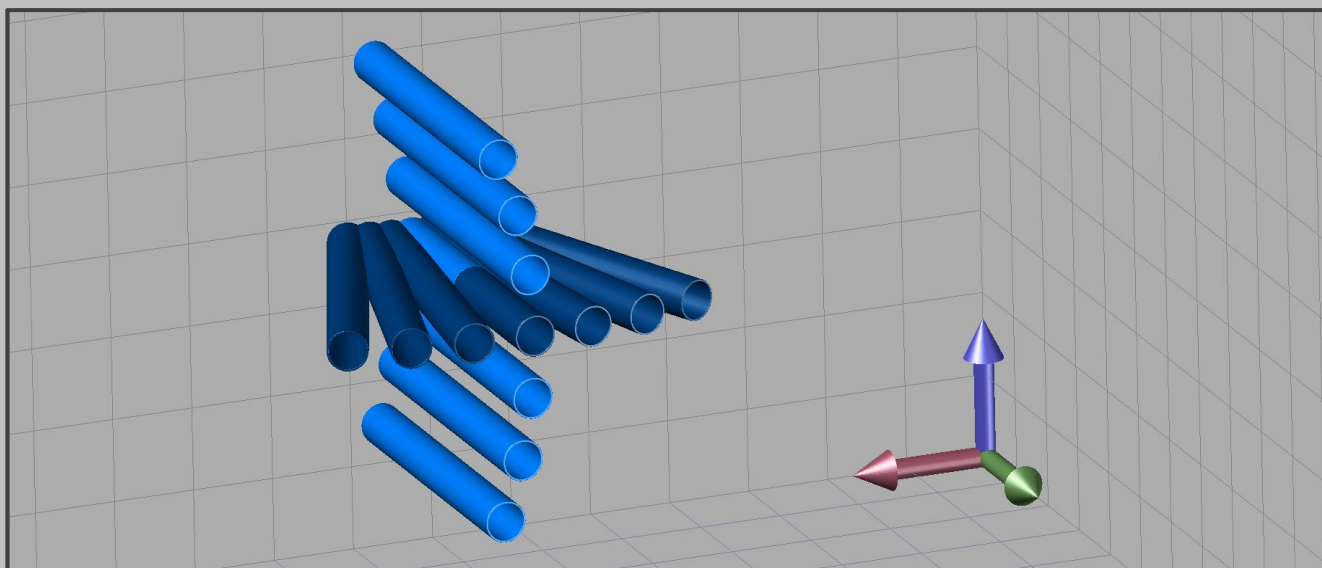
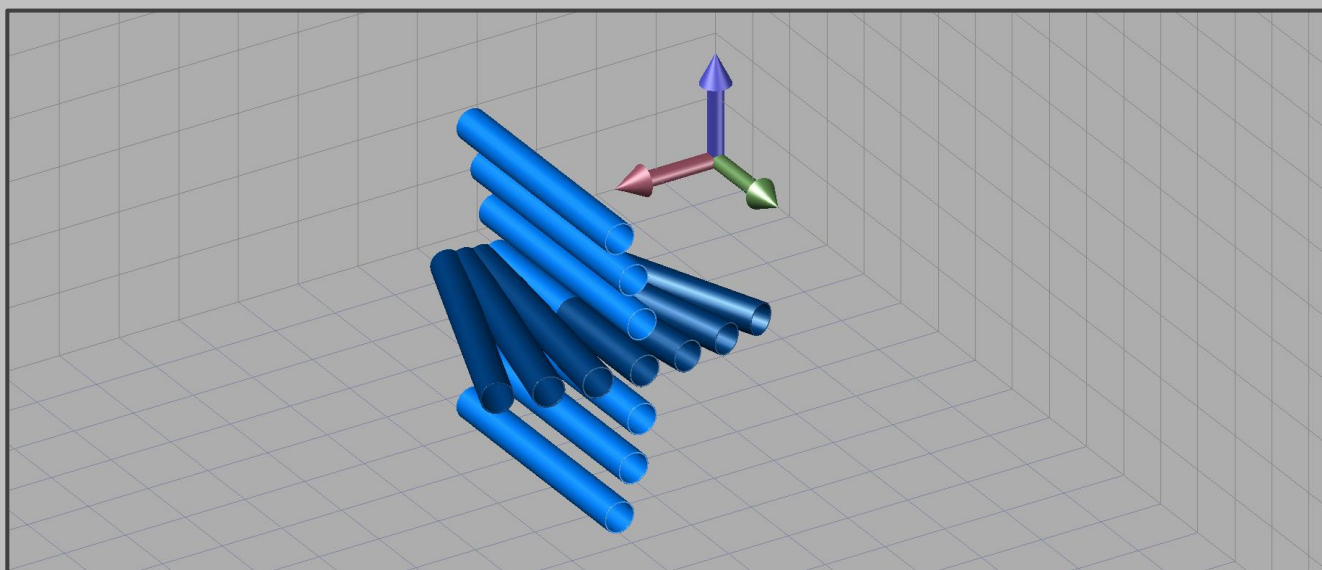
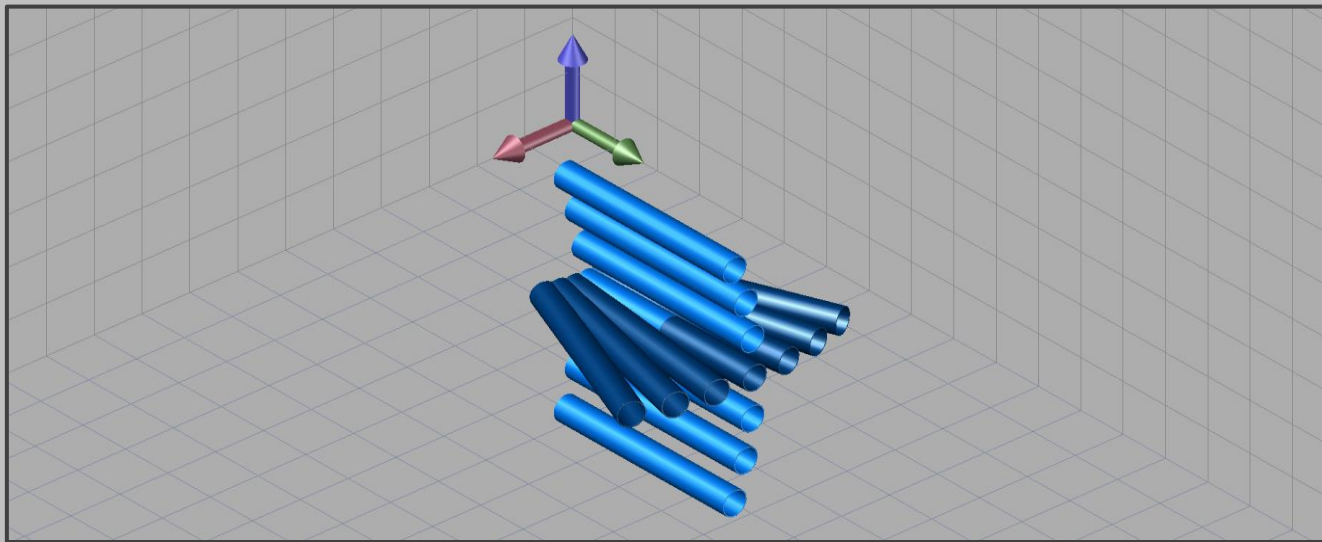

Composite True Position

FRTZF

FRTZF ABC

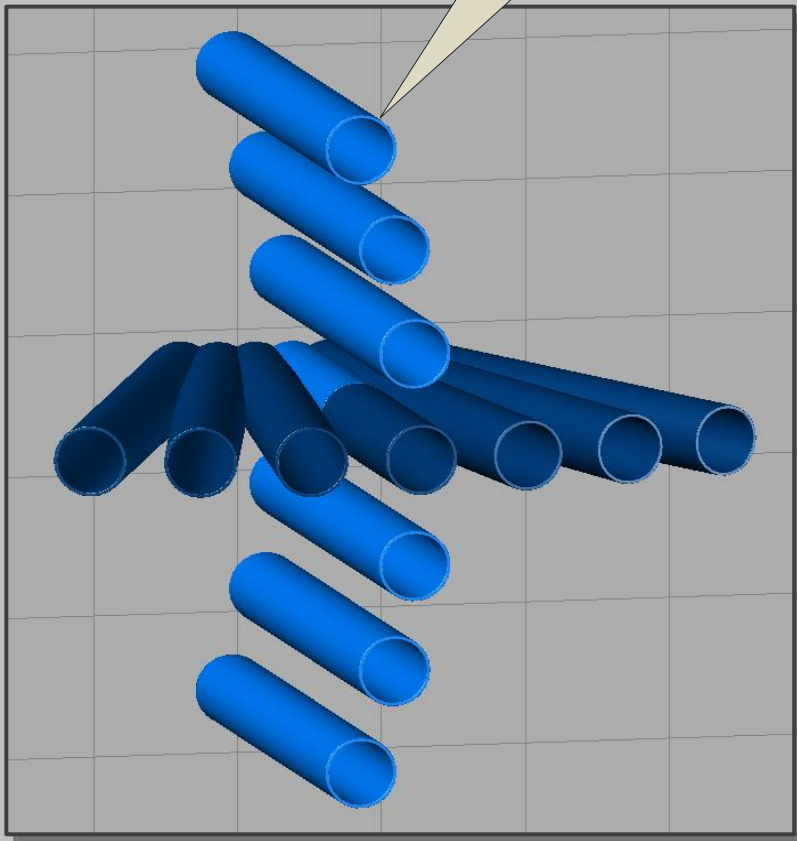

FRTZF AB

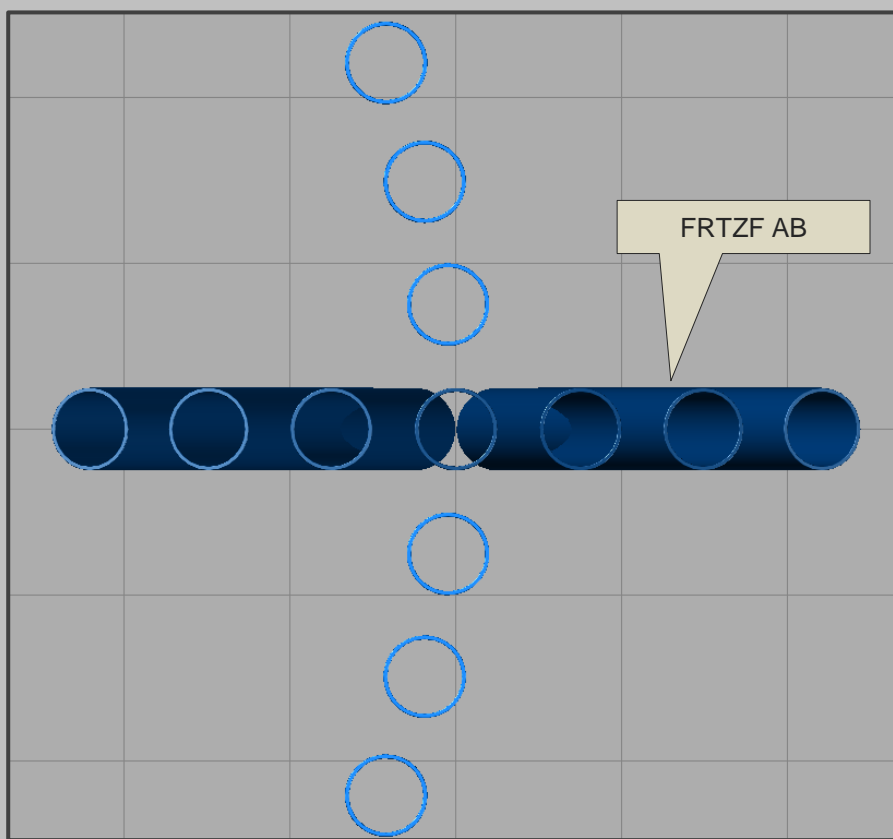

Composite True Position

FRTZF

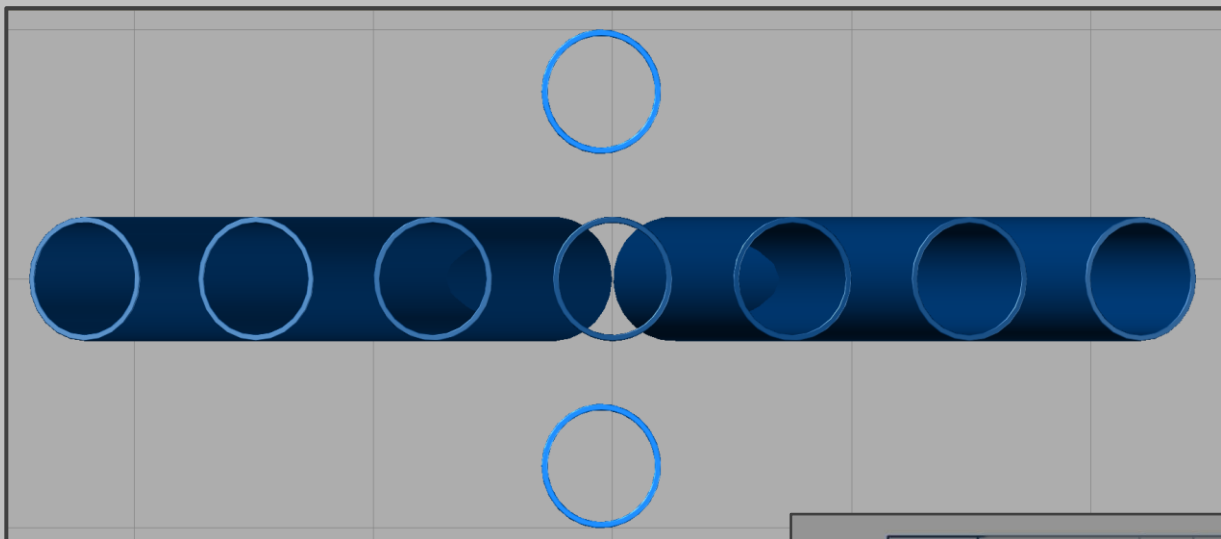

Tolerance zone always parallel to:
Y-axis

always free in:
X-direction
Z-direction

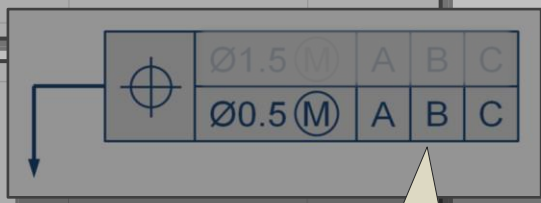

DRF ABC

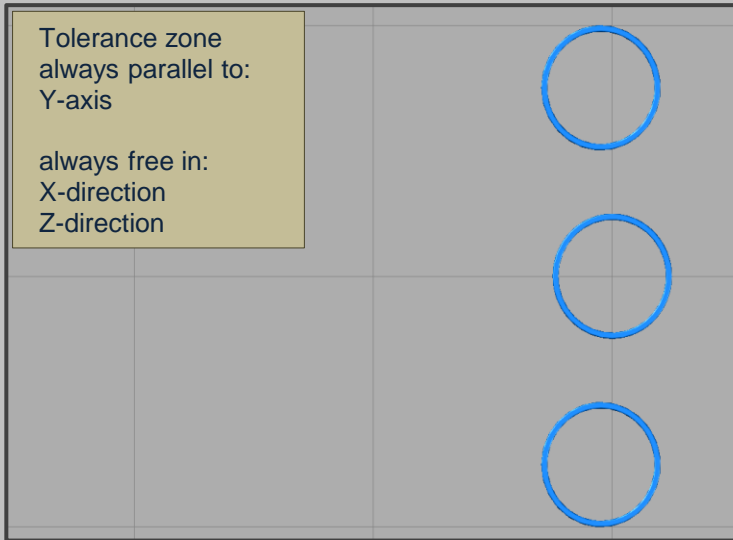

Tolerance zone always constrained to:
X/Y-plane in location and orientation

always free in: rotation around Z-axis

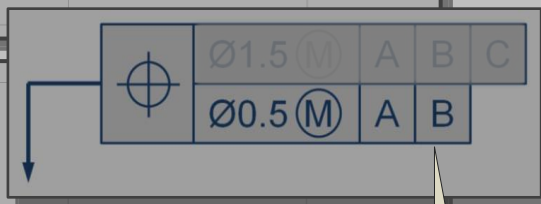

DRF AB

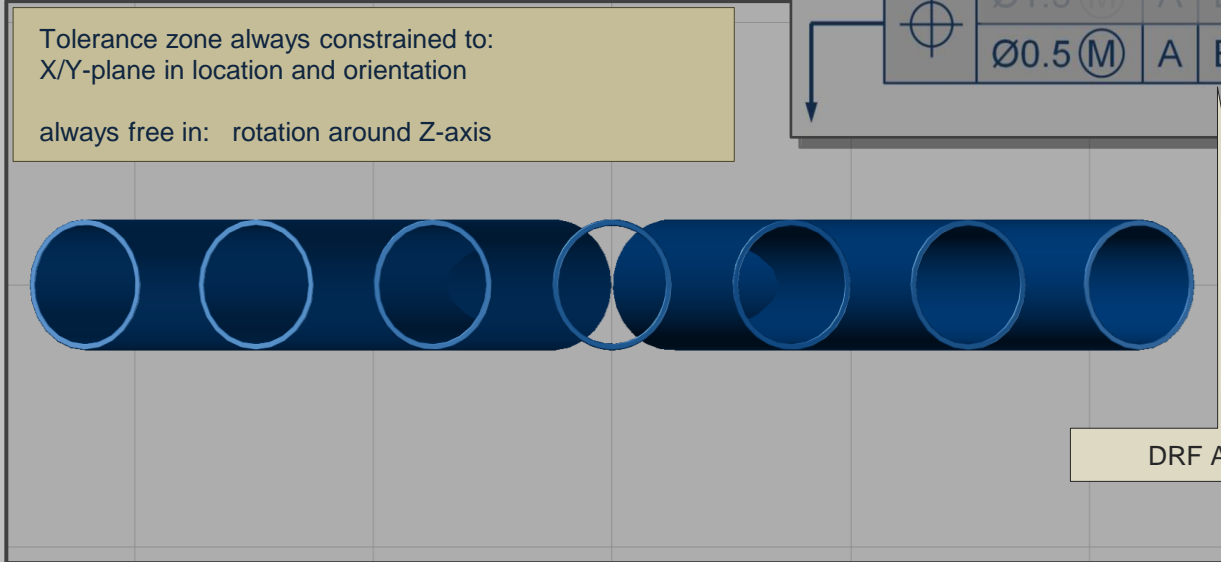

Composite True Position

FRTZF

Tolerance zone always constrained to:
X/Y-plane in location and orientation

always free in: rotation around Z-axis

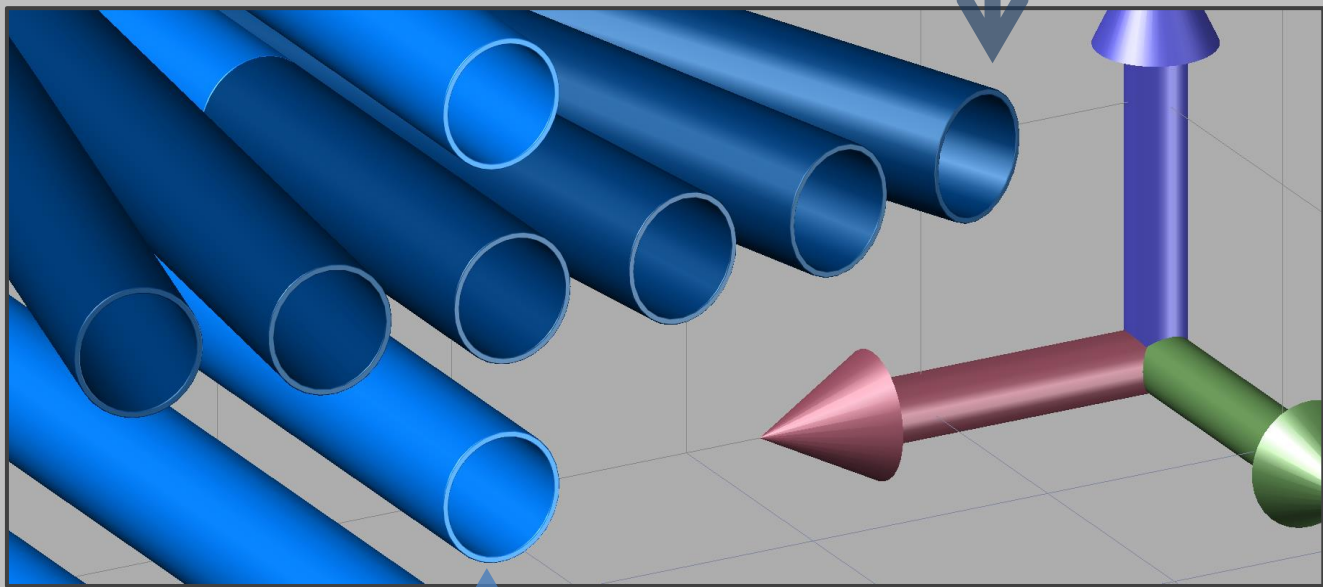

Tolerance zone
always parallel to:
X-axis
Y-axis
Z-axis

always free in:
X-direction
Y-direction
Z-direction

Composite True Position

PLTZF

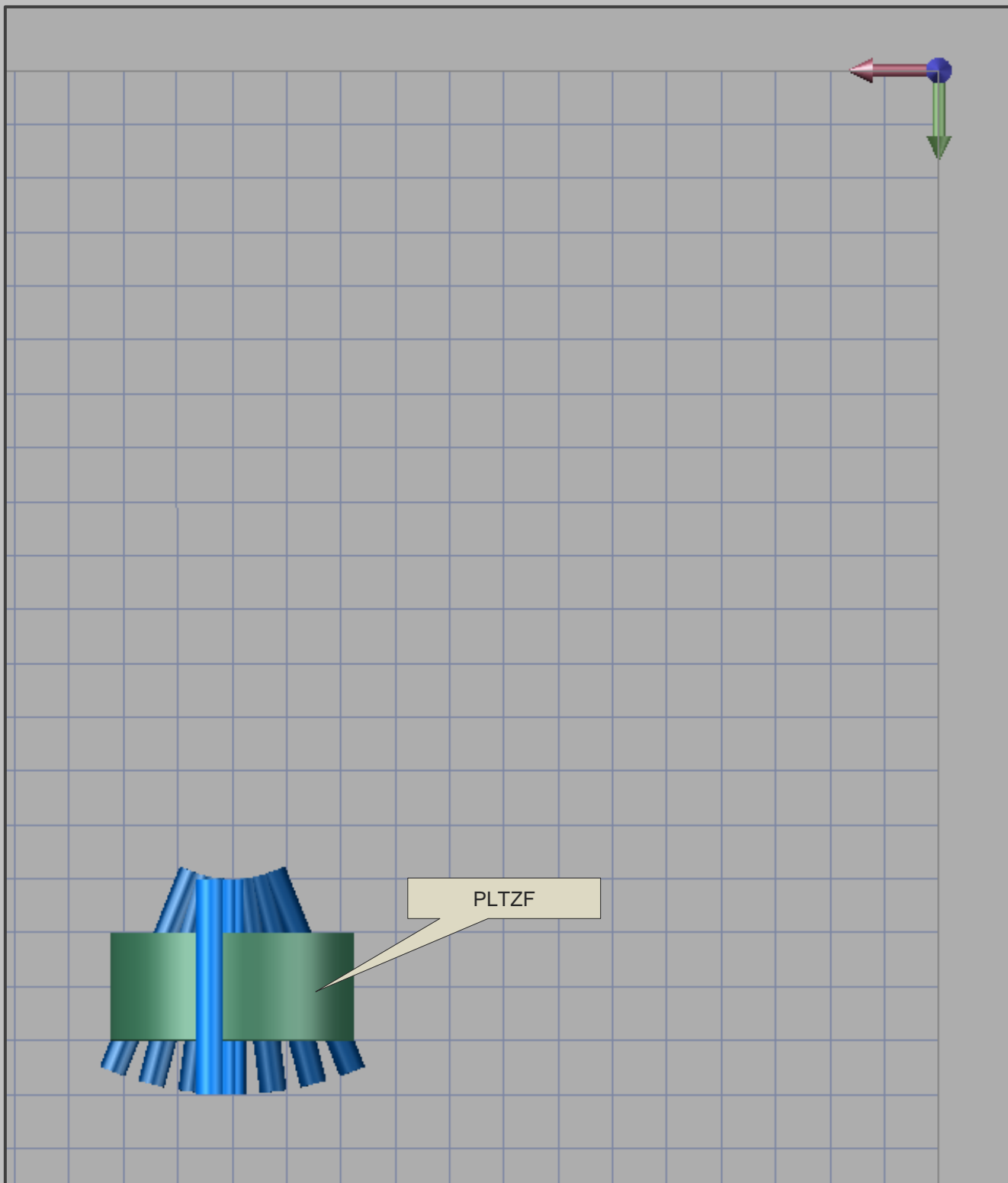

Composite True Position

PLTZF

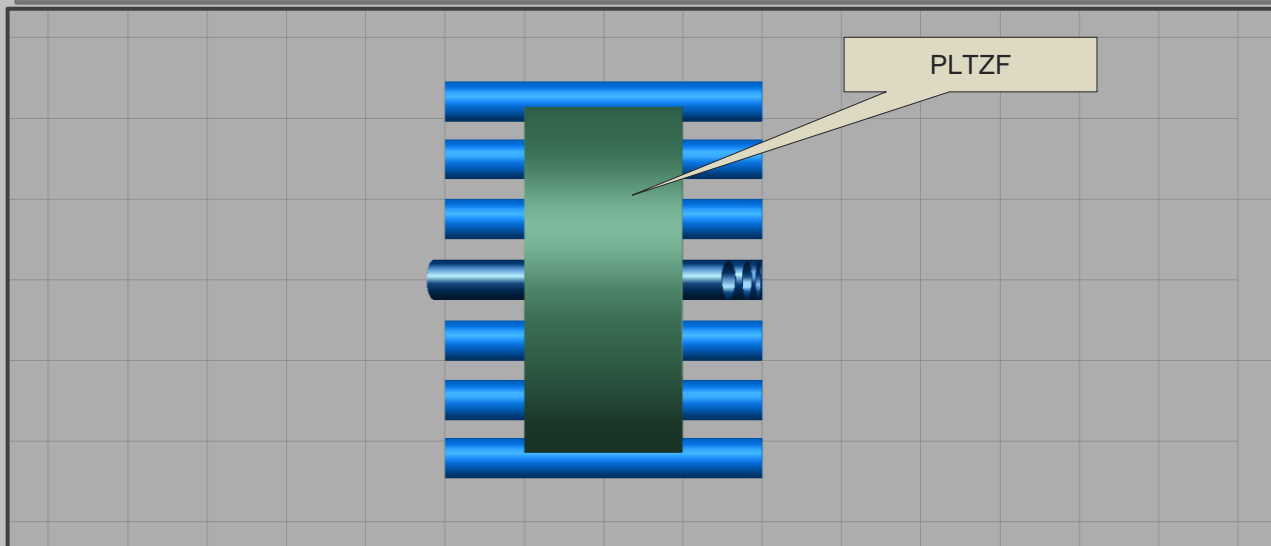
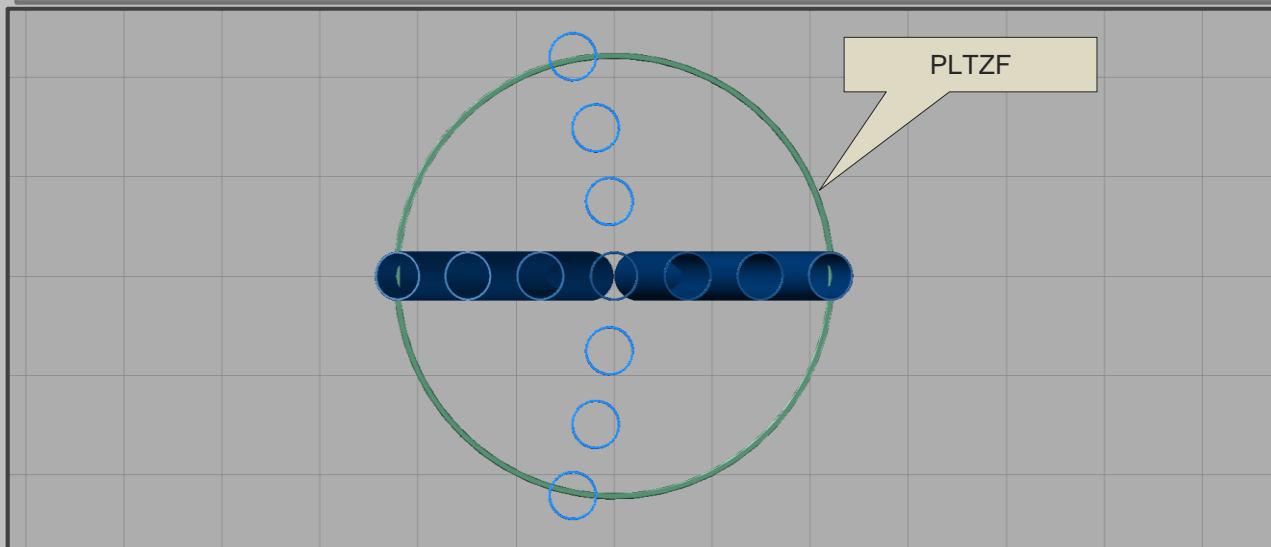
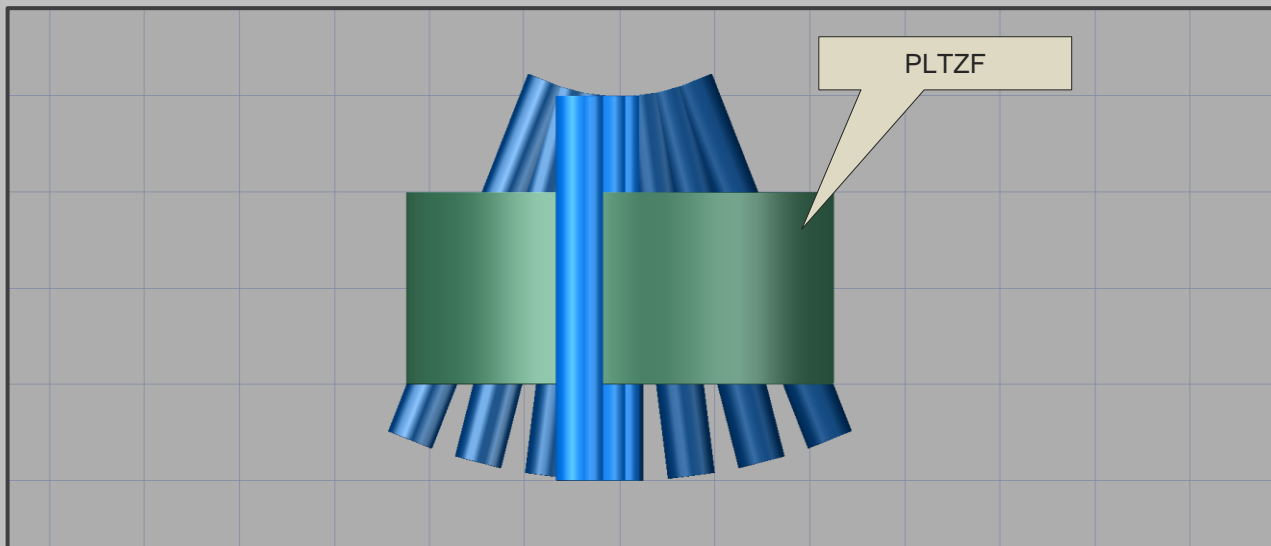

Composite True Position

	$\varnothing 1.5$ (M) A B C
	$\varnothing 0.5$ (M) A B C

PLTZF
FRTZF

	$\varnothing 1.5$ (M) A B C
	$\varnothing 0.5$ (M) A B

