

Profile Tolerance Calculation

Illustrated explanation, and examples

Contents:

1. Bilateral tolerance zone - equally distributed around nominal dimension.
2. Bilateral tolerance zone - unequally distributed around nominal dimension.
3. Unilateral tolerance zone - inside material.
4. Unilateral tolerance zone - outside material.
5. Unilateral tolerance zone - inwards to infinity.
6. Unilateral tolerance zone - outwards to infinity.

Profile Tolerance Calculation

Tolerance zone shape: **Bilateral (Equally-Distributed)**

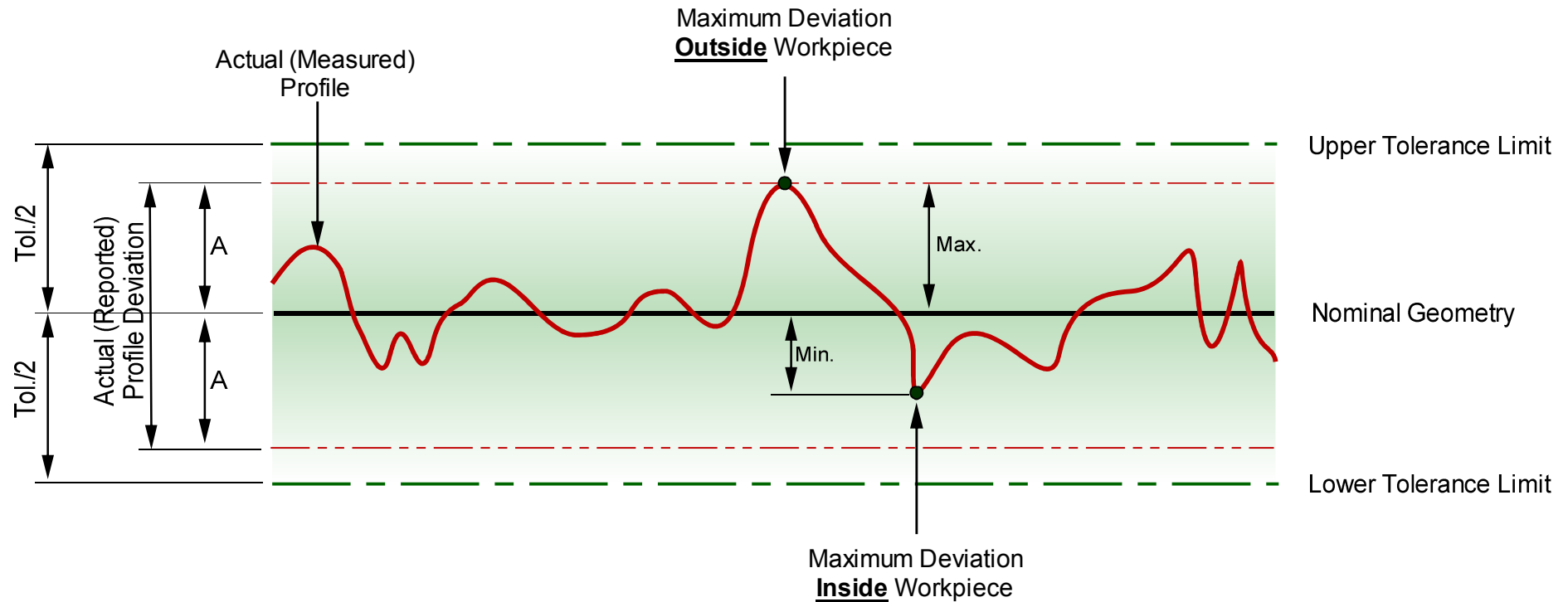

1. Find the largest deviation **OUTSIDE** workpiece (Max).
2. Find the largest deviation **INSIDE** workpiece (Min).
3. **A** = Largest **ABSOLUTE** value of either Max, or Min.
4. Reported **Actual** profile deviation = **2xA**

Profile Tolerance Calculation

Tolerance zone shape: **Bilateral (Equally-Distributed)**

| Sigma | Form | Points |
|--------|----------|----------|
| 0.0051 | 0.0641 | 486 |
| Min | Point no | Point no |
| 0.0185 | 185 | 251 |
| | | Max |
| | | 0.0456 |

Actual: 0.0912



Max = 0.0456
Min = -0.0185

A = 0.0456
Actual. Profile Deviation = $2 \times A = 0.0912$

1. Find the largest deviation **OUTSIDE** workpiece (Max).
2. Find the largest deviation **INSIDE** workpiece (Min).
3. **A** = Largest **ABSOLUTE** value of either Max, or Min.
4. Reported **Actual** profile deviation = $2 \times A$

Profile Tolerance Calculation

Tolerance zone shape: **Bilateral (Unequally-Distributed)**

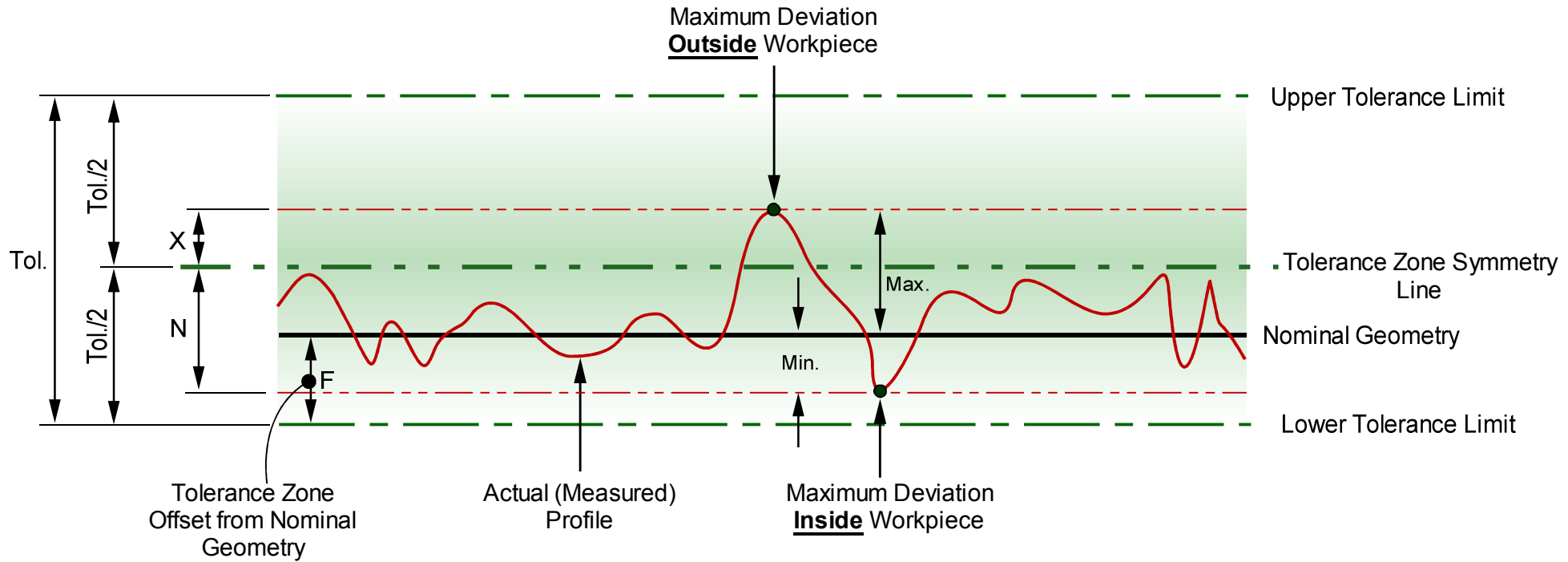

1. Construct the **symmetry line** for the tolerance zone.
2. Find the largest deviation **OUTSIDE** workpiece (Max).
3. Find the largest deviation **INSIDE** workpiece (Min).
4. **X** = Distance between **Max** and tolerance zone **symmetry line**.
5. **N** = Distance between **Min** and tolerance zone **symmetry line**.
6. **A** = Largest value of either **X**, or **N**.
7. Reported **Actual** profile deviation = **2xA**

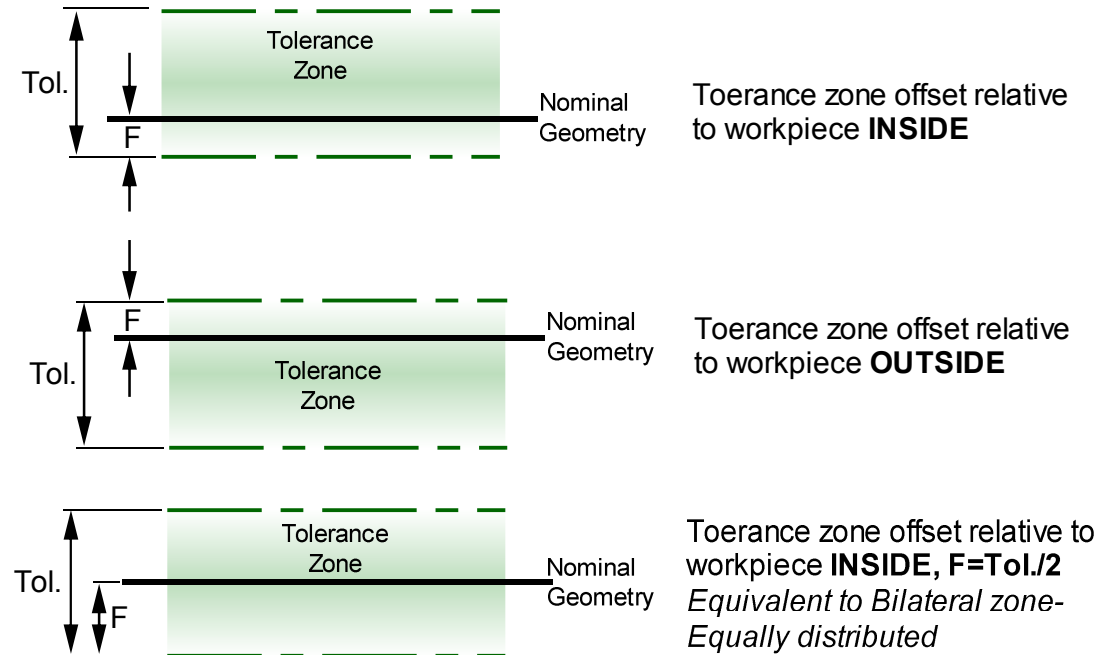

Profile Tolerance Calculation

Tolerance zone shape: *Bilateral (Unequally-Distributed)*

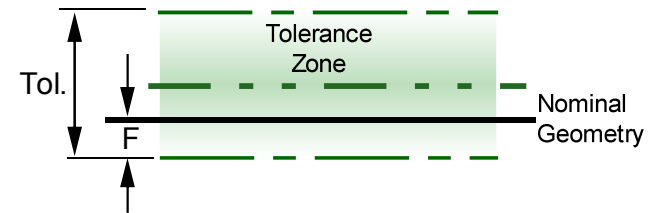
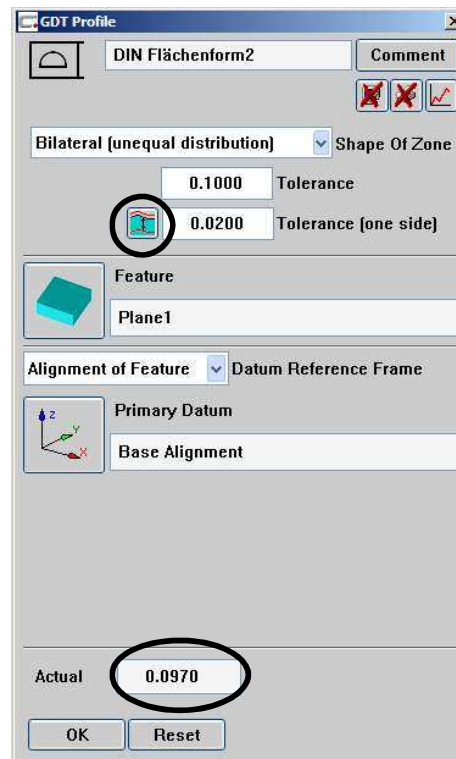
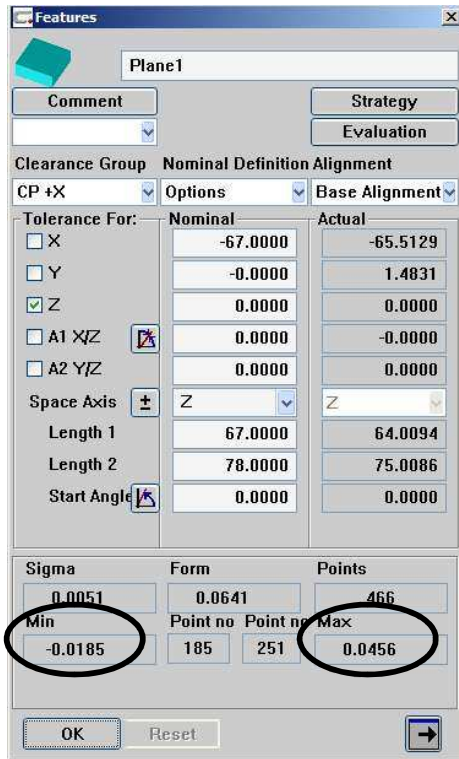

Max = 0.0456
 Min = -0.0185
 Tol = 0.1
 F = 0.02 to workpiece **INSIDE**

$$\text{Tol. Zone Symmetry Line Location} = \text{Tol./2} - F = 0.05 - 0.02 = 0.03$$

$$X = 0.0456 - 0.0300 = 0.0156$$

$$N = 0.0185 + 0.0300 = \mathbf{0.0485}$$

$$A = 0.0485$$

$$\text{Actual. Profile Deviation} = 2xA = 0.0970$$

Profile Tolerance Calculation

Tolerance zone shape: **Bilateral (Unequally-Distributed)**

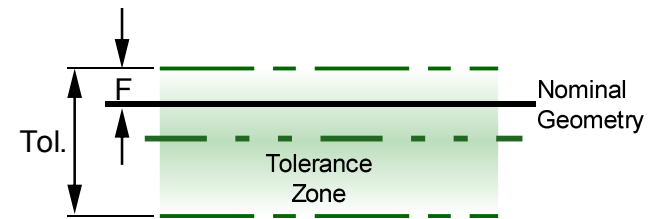
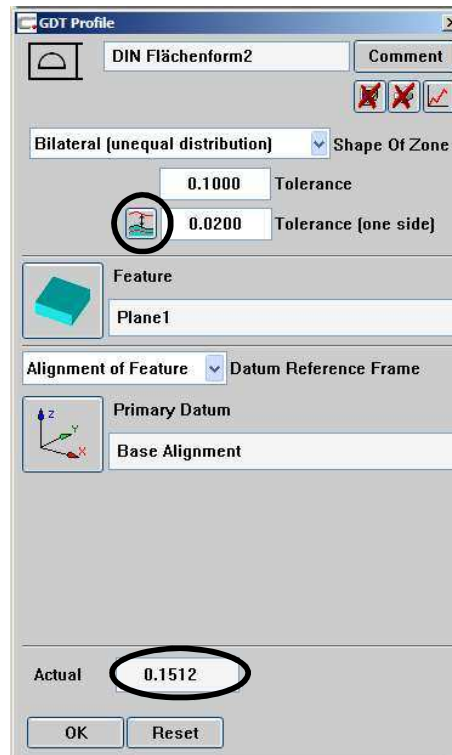
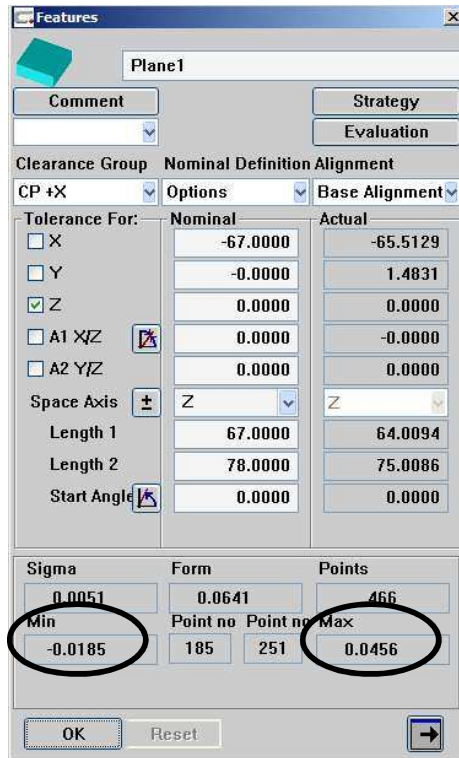

$$\text{Max} = 0.0456$$

$$\text{Min} = -0.0185$$

$$\text{Tol} = 0.1$$

$$F = 0.02 \text{ to workpiece } \mathbf{OUTSIDE}$$

$$\begin{aligned} \text{Tol. Zone Symmetry Line Location} &= F - \text{Tol./2} \\ &= 0.02 - 0.05 = -0.03 \end{aligned}$$

$$X = 0.0456 + 0.0300 = \mathbf{0.0756}$$

$$N = 0.0300 - 0.0185 = 0.0215$$

$$A = 0.0756$$

$$\text{Actual. Profile Deviation} = 2xA = 0.1512$$

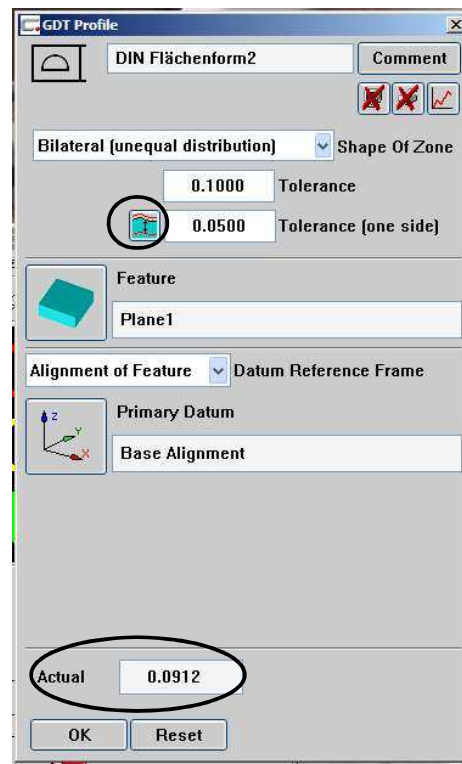
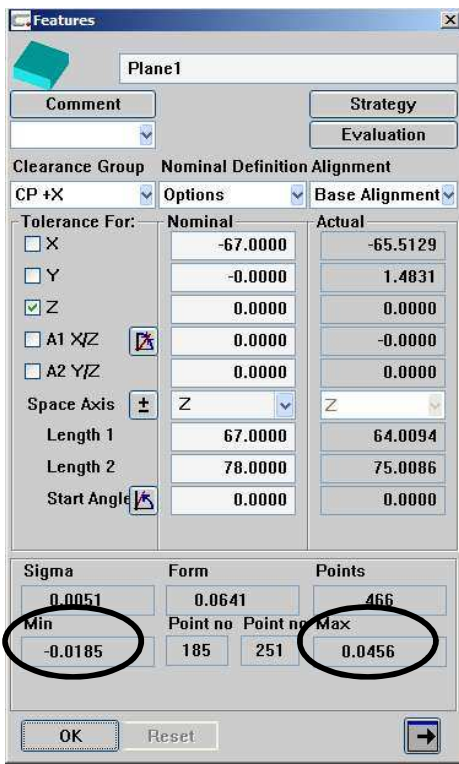

Profile Tolerance Calculation

Tolerance zone shape: **Bilateral (Unequally-Distributed)**

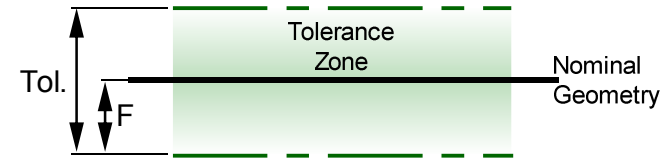

Max = 0.0456
 Min = -0.0185
 Tol = 0.1
 F = 0.05

When $F = Tol/2$, the symmetry line for the tolerance zone coincides with the nominal geometry. The tolerance zone becomes **bilateral**, and **equally distributed** around the nominal geometry. The material side from which to offset the tolerance zone becomes irrelevant, and the same result is obtained from all three cases (bilateral-equally distributed, INSIDE/OUTSIDE).

Tol. Zone Symmetry Line Location = $F - Tol./2 = 0.0$

X = 0.0456
 N = 0.0300

A = 0.0456
 Actual. Profile Deviation = $2xA = 0.0912$

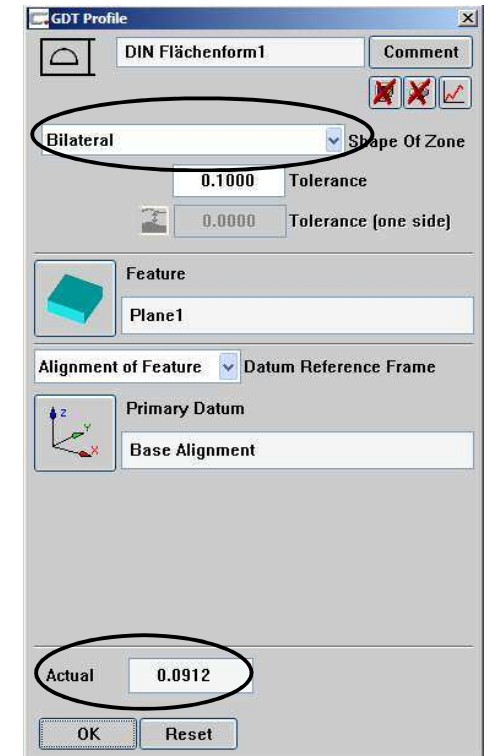
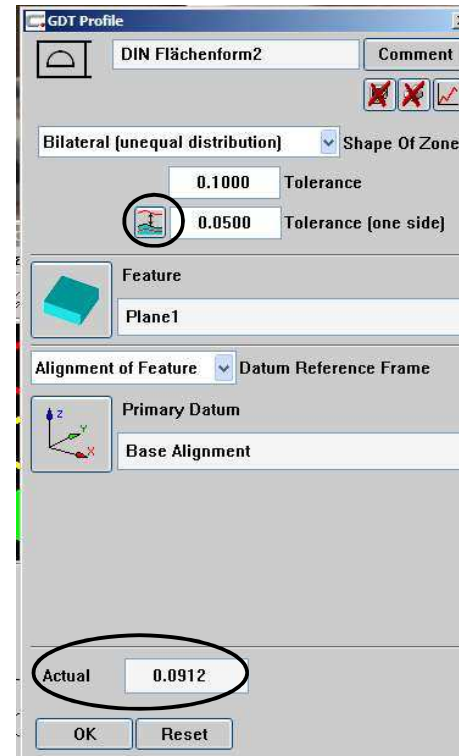

Profile Tolerance Calculation

Tolerance zone shape: *Unilateral (Inside)*

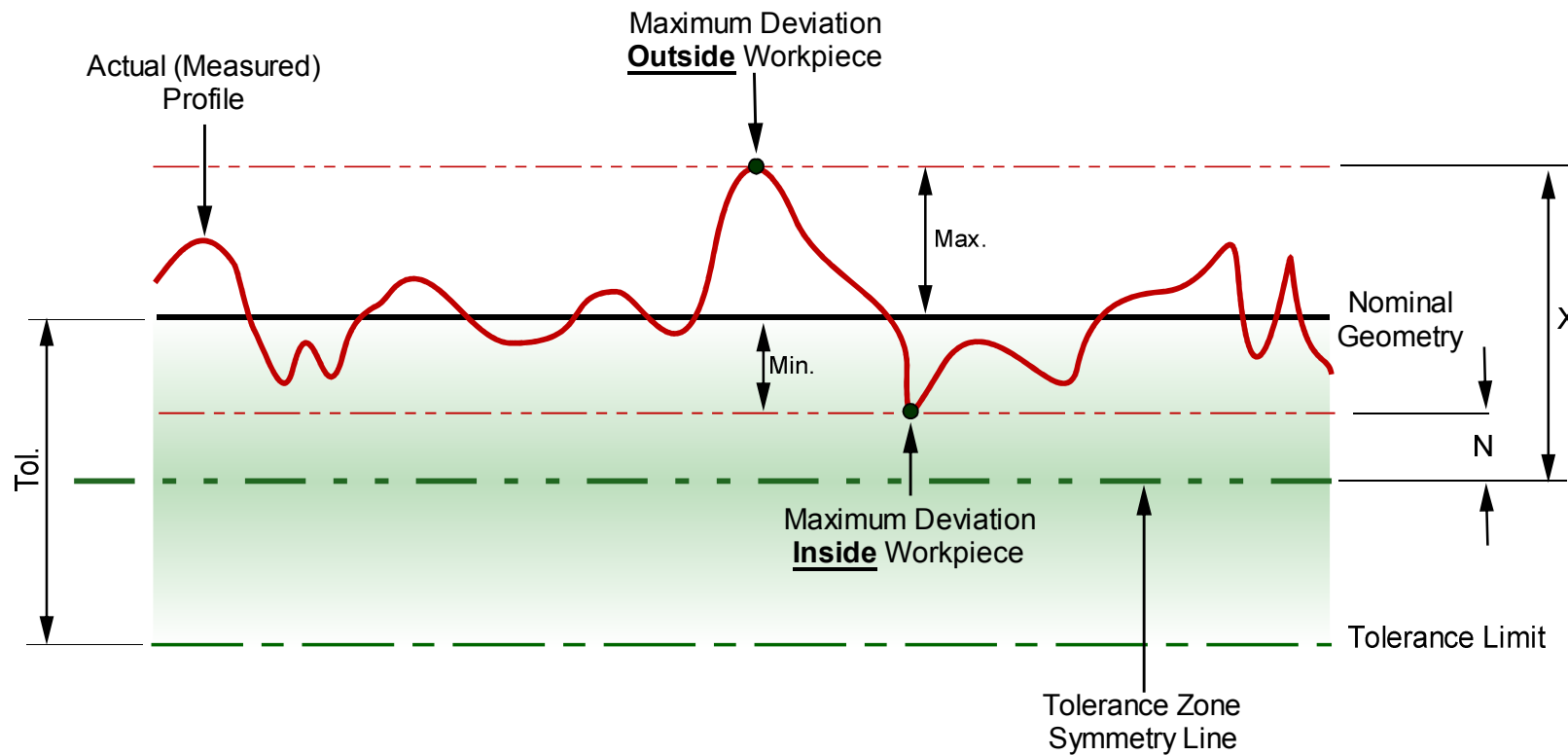

1. Construct the symmetry line of the tolerance zone.
2. Find the largest deviation **OUTSIDE** workpiece (Max).
3. Find the largest deviation **INSIDE** workpiece (Min).
4. **X** = Distance between **Max** and tolerance zone **symmetry line**.
5. **N** = Distance between **Min** and tolerance zone **symmetry line**.
6. **A** = **Largest** of either **X**, **N**.
7. Reported **Actual** profile deviation = **2xA**.

Profile Tolerance Calculation

Tolerance zone shape: *Unilateral (Inside)*

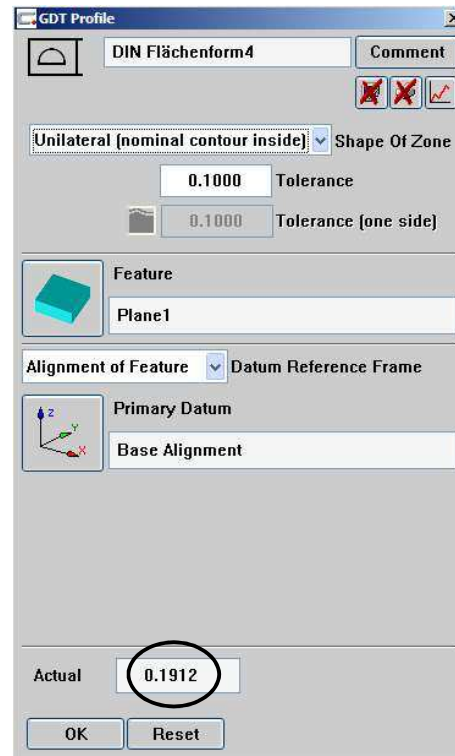
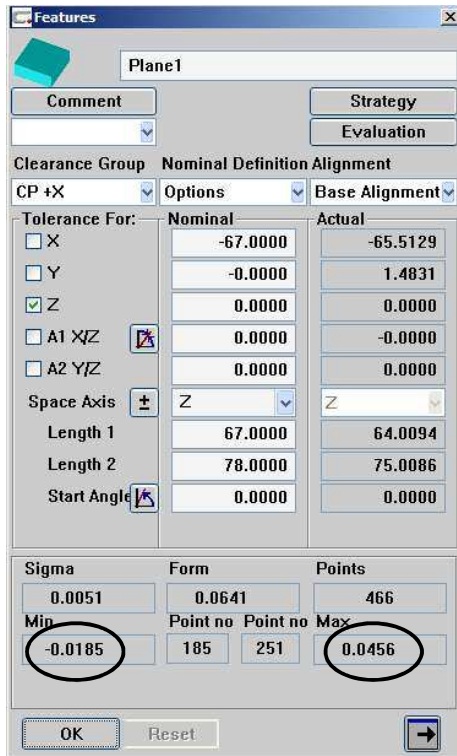

Max = 0.0456
 Min = -0.0185
 Tol = 0.1

Tol. Zone Symmetry line location = -0.05
 $X = 0.0456 + 0.0500 = 0.0956$
 $N = 0.0500 - 0.0185 = 0.0315$

$A = 0.0956$
 Actual. Profile Deviation = $2xA = 0.1912$

Profile Tolerance Calculation

Tolerance zone shape: **Unilateral (Outside)**

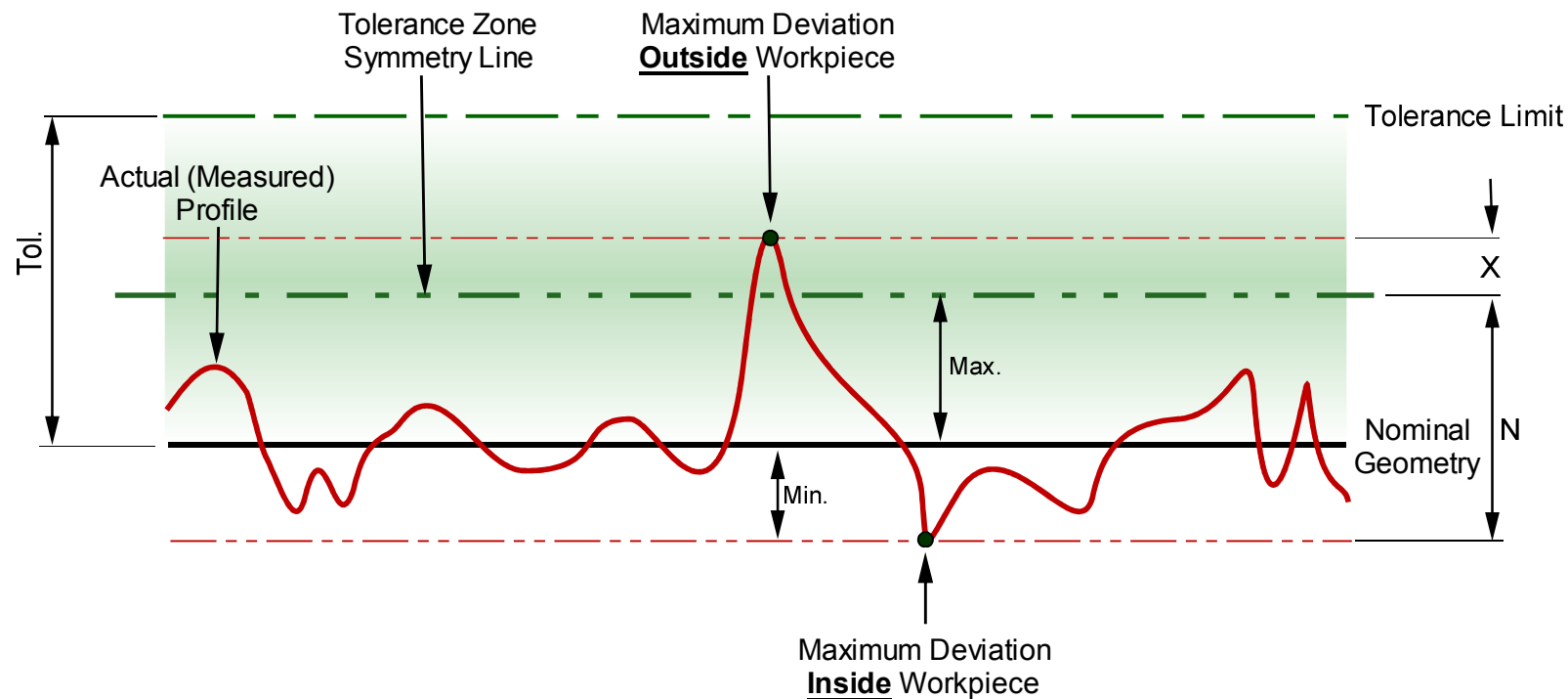

1. Construct the symmetry line of the tolerance zone.
2. Find the largest deviation **OUTSIDE** workpiece (Max).
3. Find the largest deviation **INSIDE** workpiece (Min).
4. **X** = Distance between **Max** and tolerance zone **symmetry line**.
5. **N** = Distance between **Min** and tolerance zone **symmetry line**.
6. **A** = **Largest** of either **X**, **N**.
7. Reported **Actual** profile deviation = **2xA**.

Profile Tolerance Calculation

Tolerance zone shape: *Unilateral (Outside)*

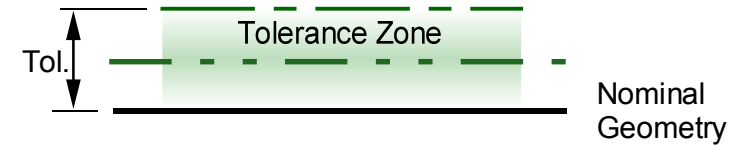
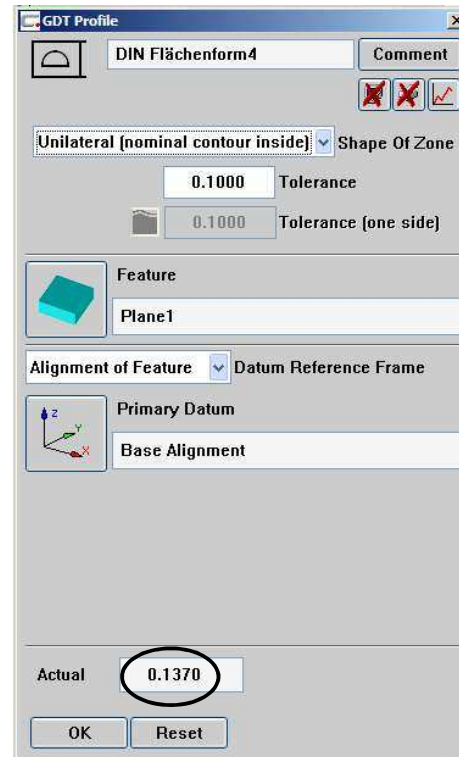
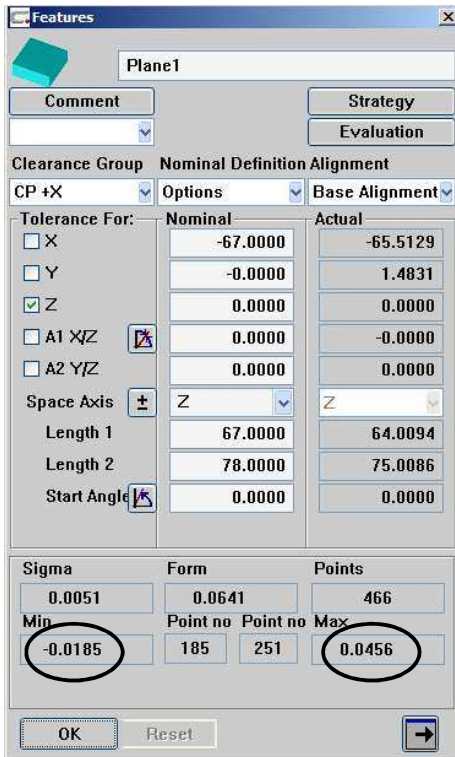

$$\begin{aligned} \text{Max} &= 0.0456 \\ \text{Min} &= -0.0185 \\ \text{Tol} &= 0.1 \end{aligned}$$

$$\begin{aligned} \text{Tol. Zone Symmetry line location} &= 0.05 \\ \mathbf{X} &= 0.0500 - 0.0456 = 0.0044 \\ \mathbf{N} &= 0.0500 + 0.0185 = 0.0685 \end{aligned}$$

$$\begin{aligned} \mathbf{A} &= 0.0685 \\ \text{Actual. Profile Deviation} &= 2xA = 0.1370 \end{aligned}$$

Profile Tolerance Calculation

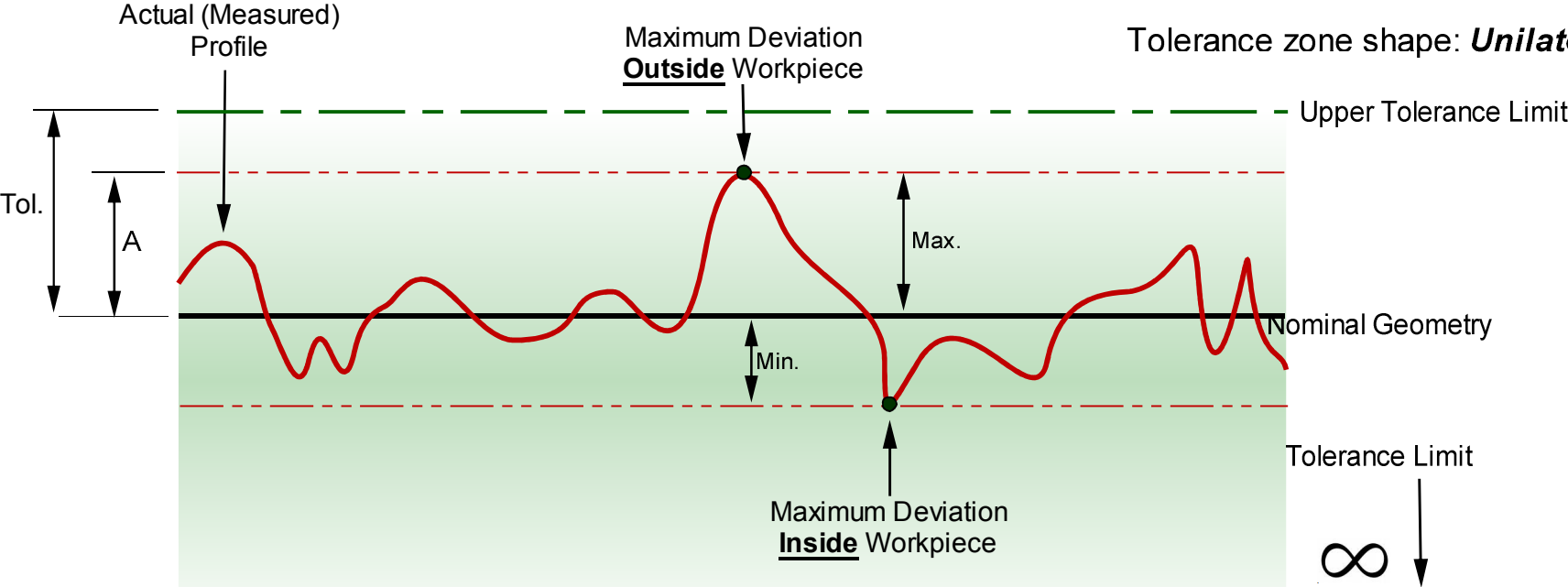

1. Find the largest deviation **OUTSIDE** workpiece (Max).
2. **A** = Max
3. Reported **Actual** profile deviation = **A**.

Features

Plane1

Comment Strategy Evaluation

Clearance Group Nominal Definition Alignment

CP +X Options Base Alignment

| Tolerance For: | Nominal | Actual |
|---------------------------------------|----------|----------|
| <input type="checkbox"/> X | -67.0000 | -65.5129 |
| <input type="checkbox"/> Y | -0.0000 | 1.4831 |
| <input checked="" type="checkbox"/> Z | 0.0000 | 0.0000 |
| <input type="checkbox"/> A1 X/Z | 0.0000 | -0.0000 |
| <input type="checkbox"/> A2 Y/Z | 0.0000 | 0.0000 |

Space Axis Z

| Length | Nominal | Actual |
|-------------|---------|---------|
| Length 1 | 67.0000 | 64.0094 |
| Length 2 | 78.0000 | 75.0086 |
| Start Angle | 0.0000 | 0.0000 |

| Sigma | Form | Points |
|-------------|--------------|--------------|
| 0.0001 | 0.0641 | 486 |
| Min -0.0185 | Point no 185 | Point no 251 |
| | | Max 0.0456 |

OK Reset

GDT Profile

DIN Flächenform3 Comment

Inwards into infinity Shape Of Zone

0.1000 Tolerance

0.1000 Tolerance (one side)

Feature Plane1

Alignment of Feature Datum Reference Frame

Primary Datum Base Alignment

Actual 0.0456

OK Reset

Profile Tolerance Calculation

Tolerance zone shape: *Unilateral (Outwards into infinity)*

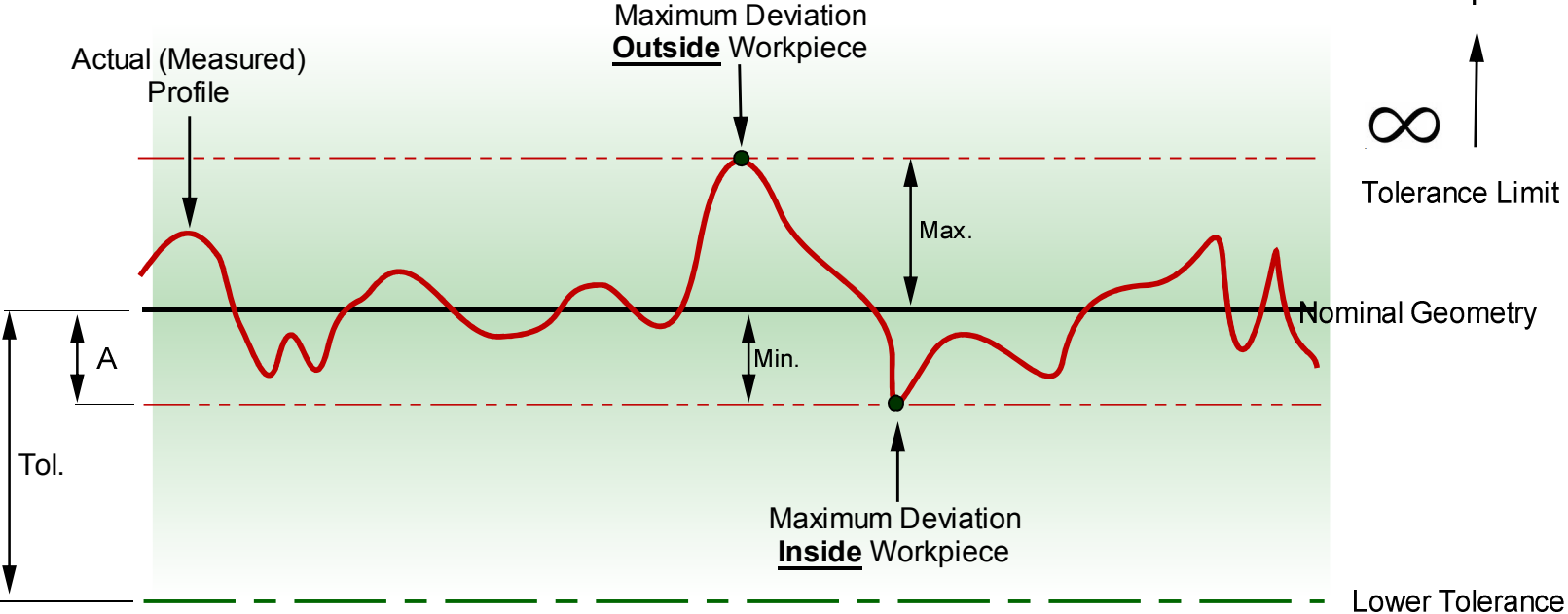

1. Find the largest deviation **INTSIDE** workpiece (Min).
2. **A = ABSOLUTE** value of Min
3. Reported **Actual** profile deviation = **A**.

Features

Plane1

Comment Strategy Evaluation

Clearance Group Nominal Definition Alignment

CP +X Options Base Alignment

Tolerance For: Nominal Actual

| | | |
|---------------------------------------|----------|----------|
| <input type="checkbox"/> X | -67.0000 | -65.5129 |
| <input type="checkbox"/> Y | -0.0000 | 1.4831 |
| <input checked="" type="checkbox"/> Z | 0.0000 | 0.0000 |
| <input type="checkbox"/> A1 XYZ | 0.0000 | -0.0000 |
| <input type="checkbox"/> A2 Y/Z | 0.0000 | 0.0000 |

Space Axis \pm Z Z

Length 1 67.0000 64.0094

Length 2 78.0000 75.0086

Start Angle 0.0000 0.0000

| Sigma | Form | Points |
|---------------|----------|---------------|
| 0.0091 | 0.0641 | 406 |
| Min | Point no | Point no |
| 0.0185 | 185 | 251 |
| | | Max |
| | | 0.0456 |

OK Reset

GDT Profile

DIN Flächenform3 Comment

Outwards into infinity Shape Of Zone

0.1000 Tolerance

0.1000 Tolerance (one side)

Feature Plane1

Alignment of Feature Datum Reference Frame

Primary Datum Base Alignment

Actual **0.0185**

OK Reset