

# Profile

- F<sub>a</sub>** **Profile deviation, total**  
Overlay of profile form deviation and profile slope deviation.
- f<sub>fa</sub>** **Profile form deviation**  
Form deviation of the profile without consideration of the slope deviation.
- f<sub>H<sub>a</sub></sub>** **Profile slope deviation**  
Slope deviation of the profile without consideration of the form deviation.
- C<sub>aa</sub>** **Profile tip relief**  
Correction of the profile through material removal on the tooth tip. Avoids jamming with the mating gear under load.
- C<sub>af</sub>** **Profile root relief**  
Correction of the profile through material removal on the tooth root. Avoids jamming with the mating gear under load.
- C<sub>a</sub>** **Profile crowning**  
Correction of the profile through convex curvature over a defined range of the tooth height. Compensates for elastic deformations of the tooth under load.

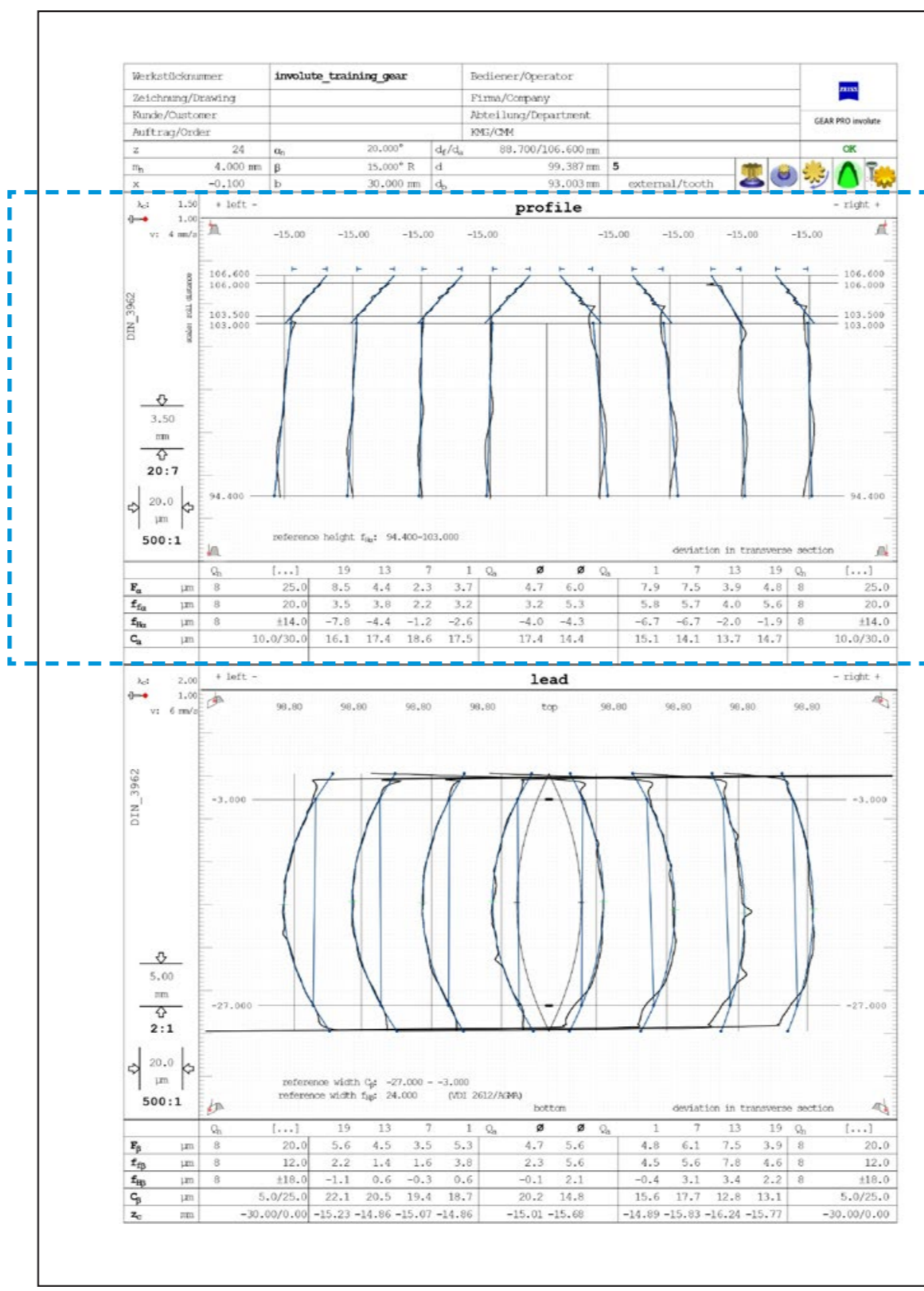
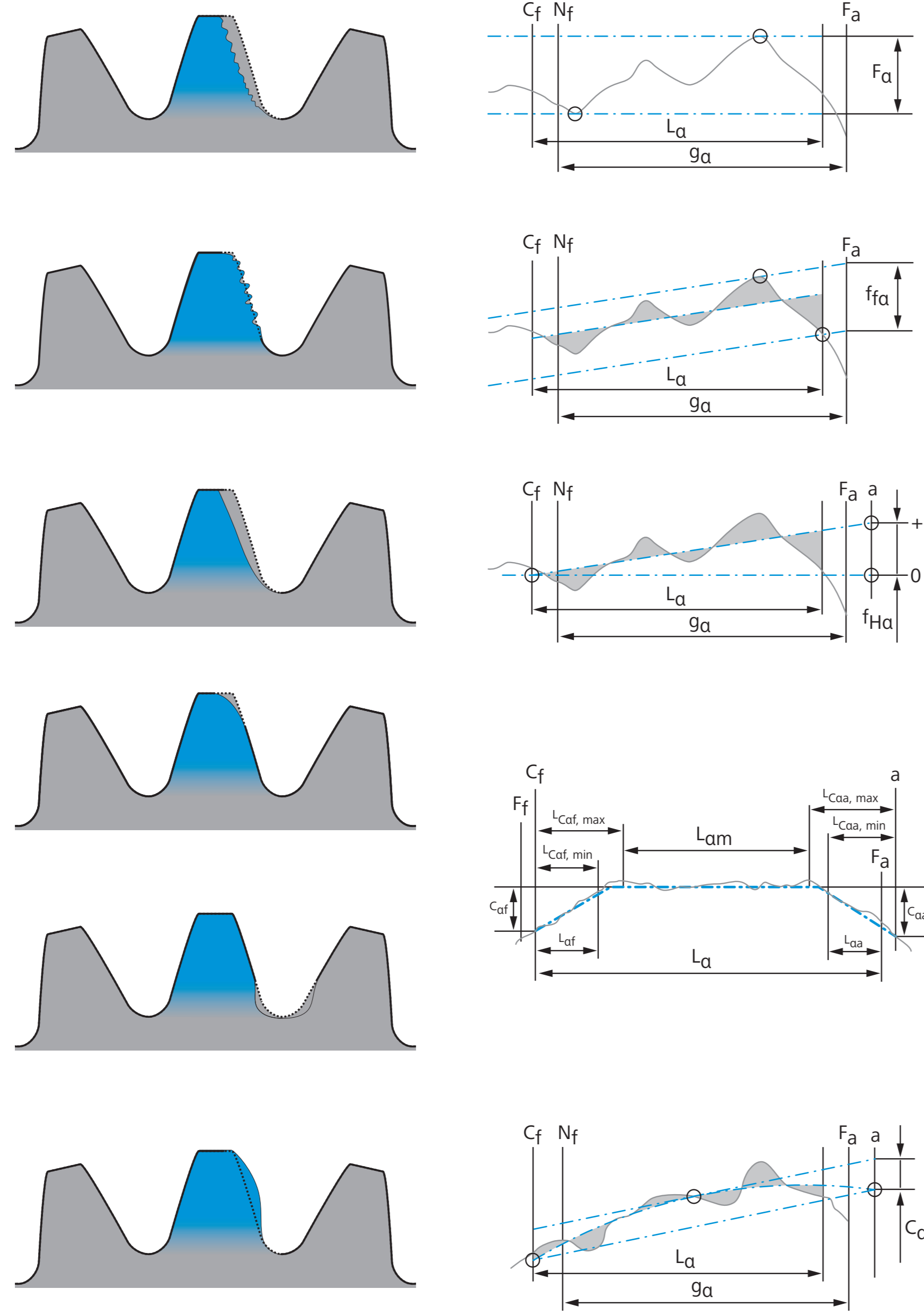

- F<sub>f</sub>** Root form circle
- C<sub>f</sub>** Start of profile evaluation
- N<sub>f</sub>** Start of active profile
- F<sub>a</sub>** Tip form circle
- a** Tip
- g<sub>a</sub>** Length of path of contact
- L<sub>a</sub>** Profile evaluation length
- L<sub>af</sub>** Profile root relief zone
- L<sub>caf</sub>** Length of profile root relief
- L<sub>am</sub>** Middle profile zone of unmodified profile
- L<sub>aa</sub>** Profile tip relief zone
- L<sub>caa</sub>** Length of profile tip relief

# Helix

- F<sub>β</sub>** **Helix deviation, total**  
Overlay of helix form deviation and helix slope deviation.
- f<sub>ff<sub>β</sub></sub>** **Helix form deviation**  
Form deviation of the helix without consideration of the slope deviation.
- f<sub>H<sub>β</sub></sub>** **Helix slope deviation**  
Slope deviation of the helix without consideration of the form deviation.
- C<sub>βI</sub>** **Helix end relief at datum face**  
Correction of the helix through material removal on the flank ends of the datum face. Avoids jamming with the mating gear under load.
- C<sub>βII</sub>** **Helix end relief at non-datum face**  
Correction of the helix through material removal on the flank ends of the non-datum face. Avoids jamming with the mating gear under load.
- C<sub>β</sub>** **Helix crowning**  
Correction of the helix through convex curvature over the face width. Compensates for elastic deformations of the tooth under load.

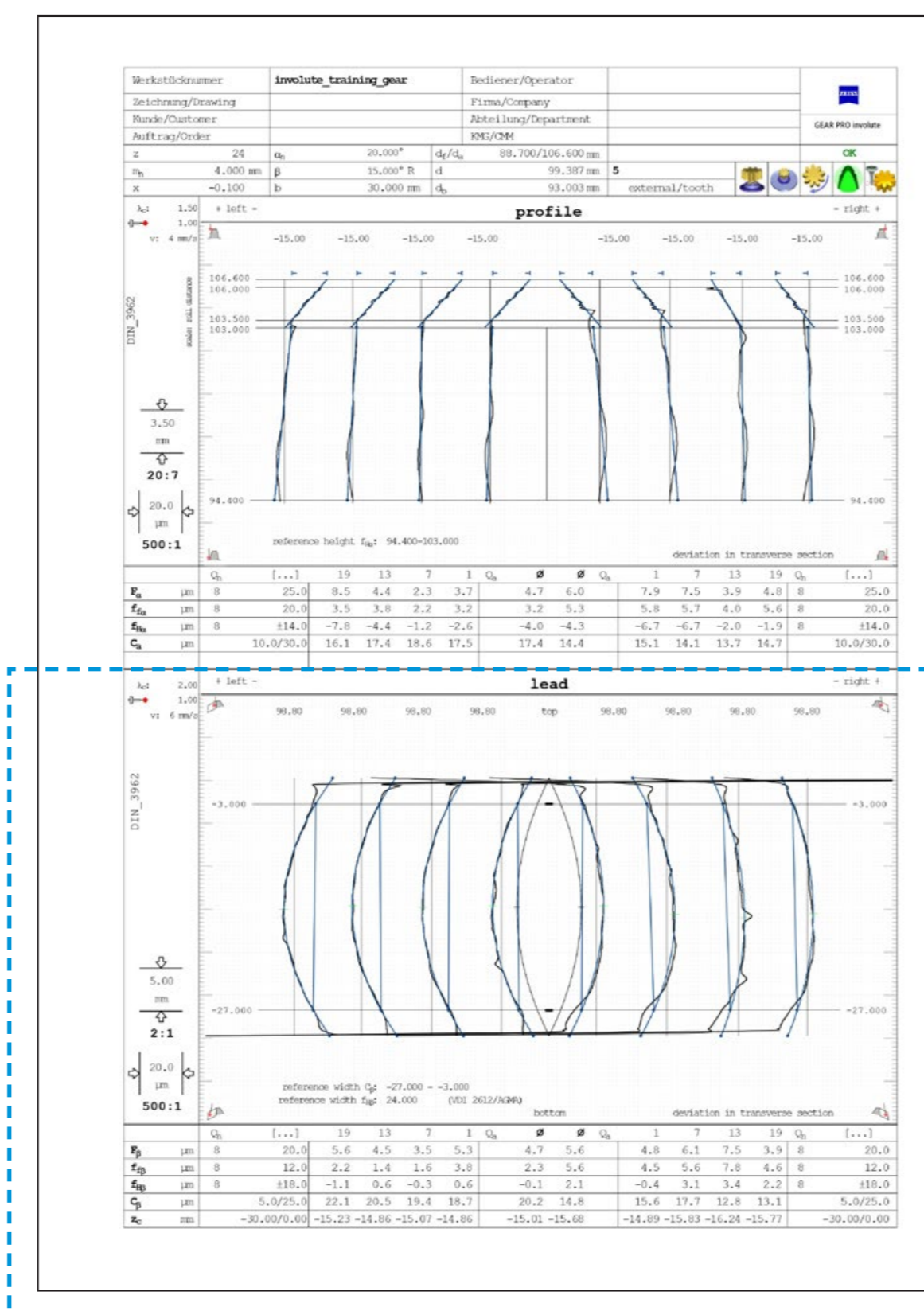
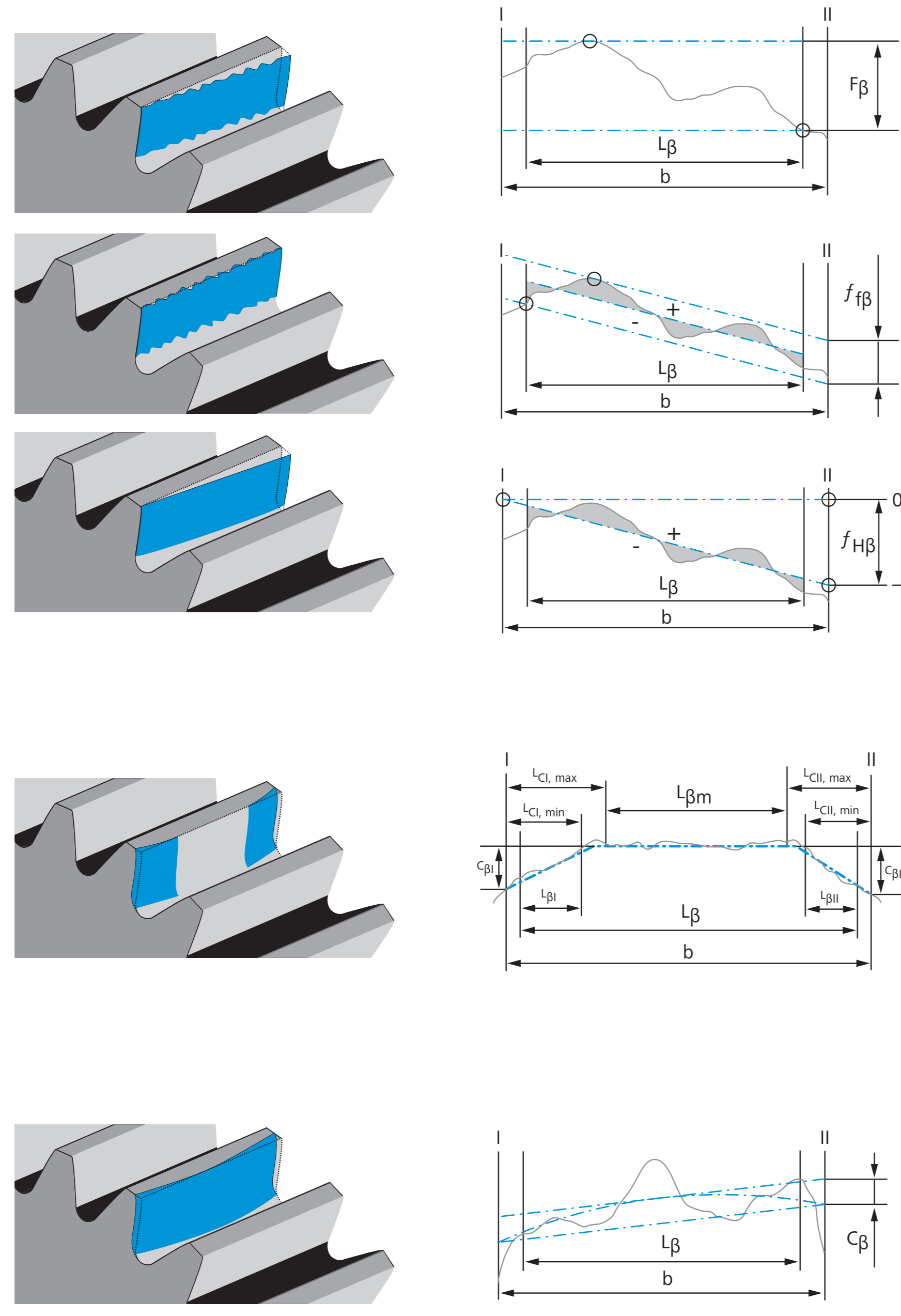

- I** Datum face
- II** Non-datum face
- b** Face width
- L<sub>β</sub>** Helix evaluation length
- L<sub>βI</sub>** Helix end relief zone (datum face)
- L<sub>βII</sub>** Length of helix end relief (datum face)
- L<sub>βm</sub>** Middle helix zone of unmodified helix
- L<sub>βI</sub>** Helix end relief zone (non-datum face)
- L<sub>βII</sub>** Length of helix end relief (non-datum face)

# Pitch

- F<sub>p</sub>** **Cumulative pitch deviation, total**  
Range of the positional deviation of all right (left) flanks to the nominal position, with the flanks being analyzed independently.
- f<sub>p</sub>** **Single pitch deviation**  
Greatest unsigned positional deviation of all individual right (left) flanks to the preceding right (left) flank.
- f<sub>u</sub>** **Adjacent pitch difference**  
Greatest unsigned difference of all individual single pitch deviations of all right (left) flanks.

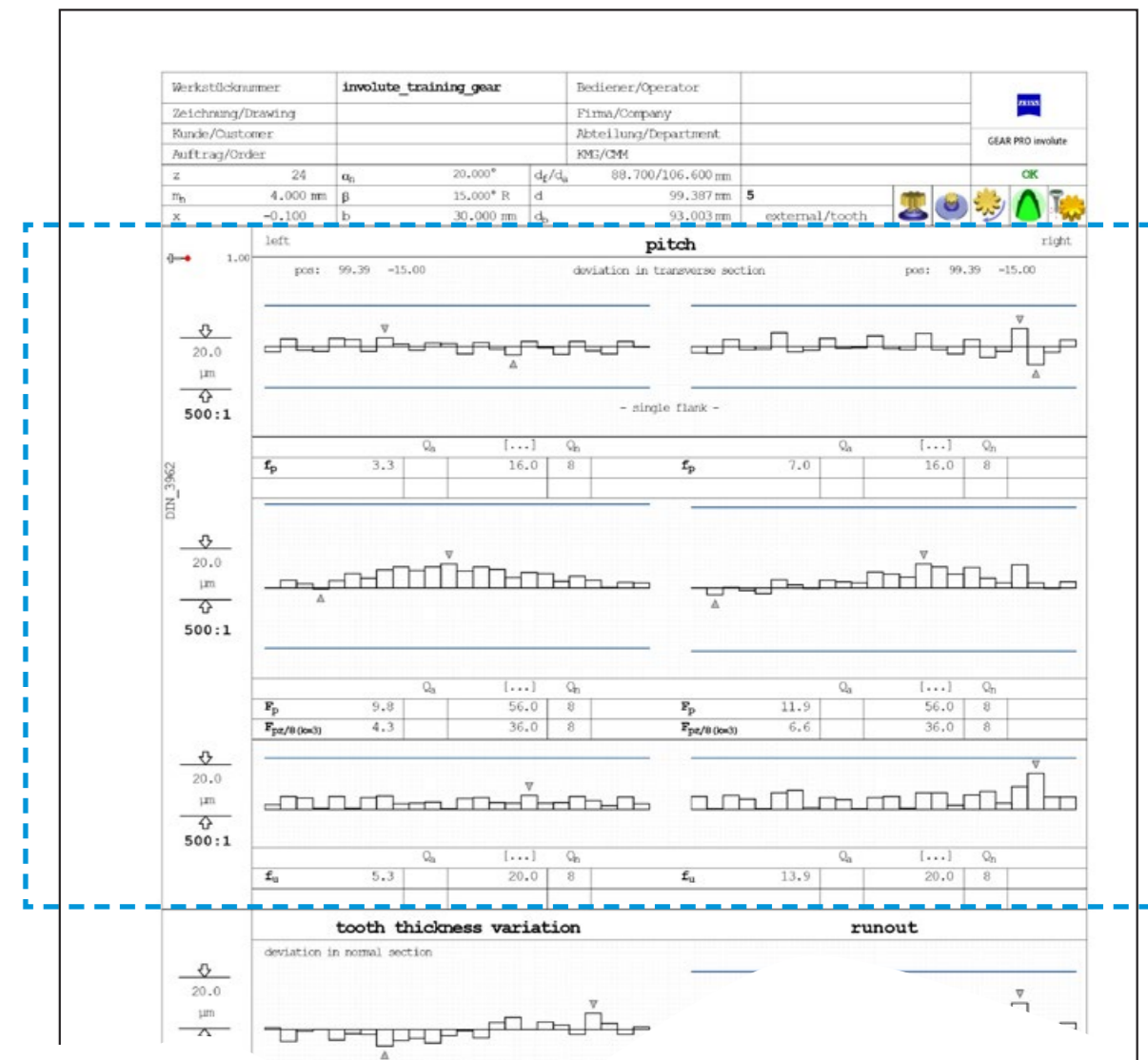
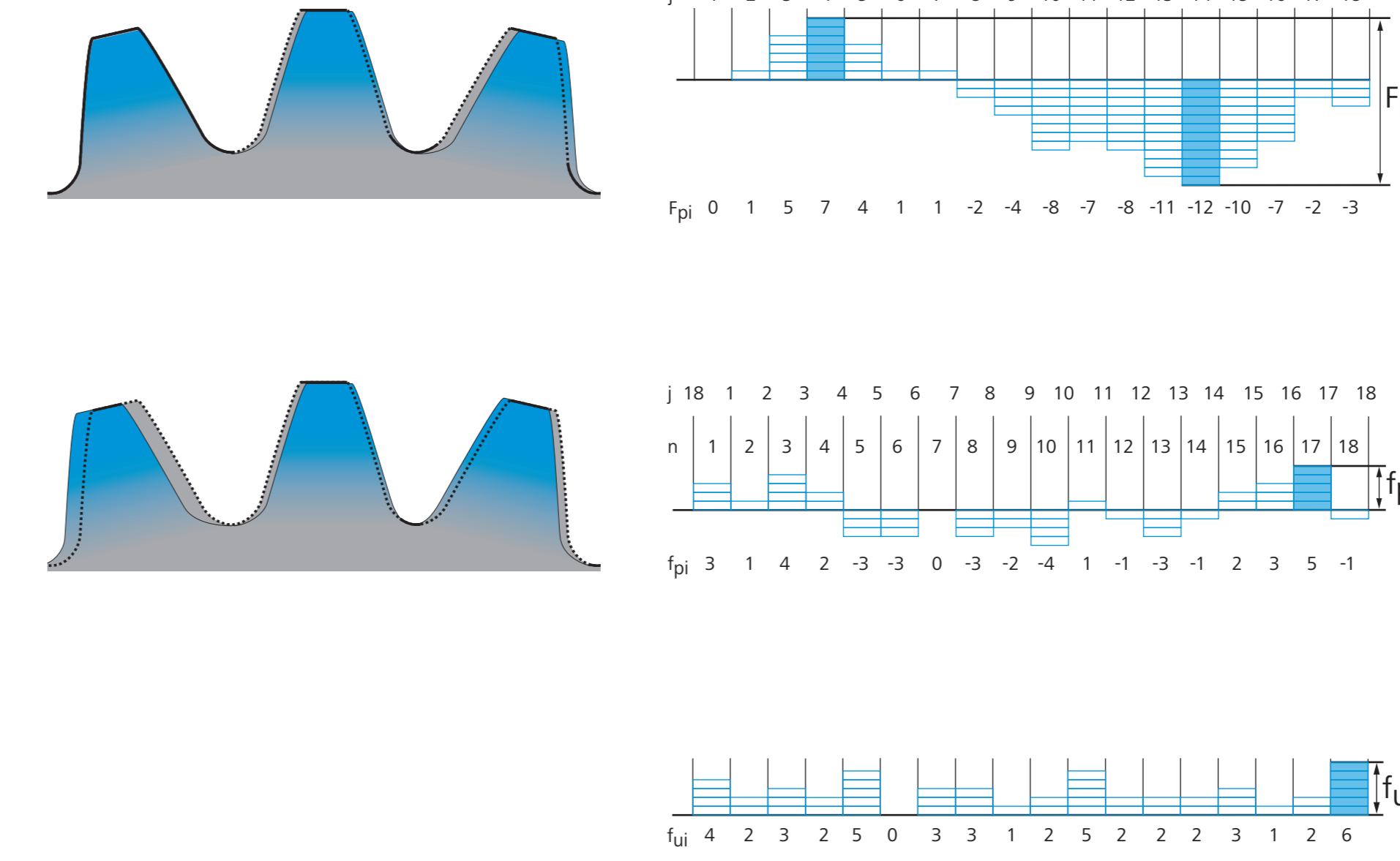

# Radial runout

- F<sub>r</sub>** **Radial runout deviation**  
Range of the radial positional deviation of all gaps. Measured by placing a measuring sphere on both flanks of all gaps.
- f<sub>e</sub>** **Eccentricity**  
Eccentricity of the gearing to the reference system axis (bore/shaft).

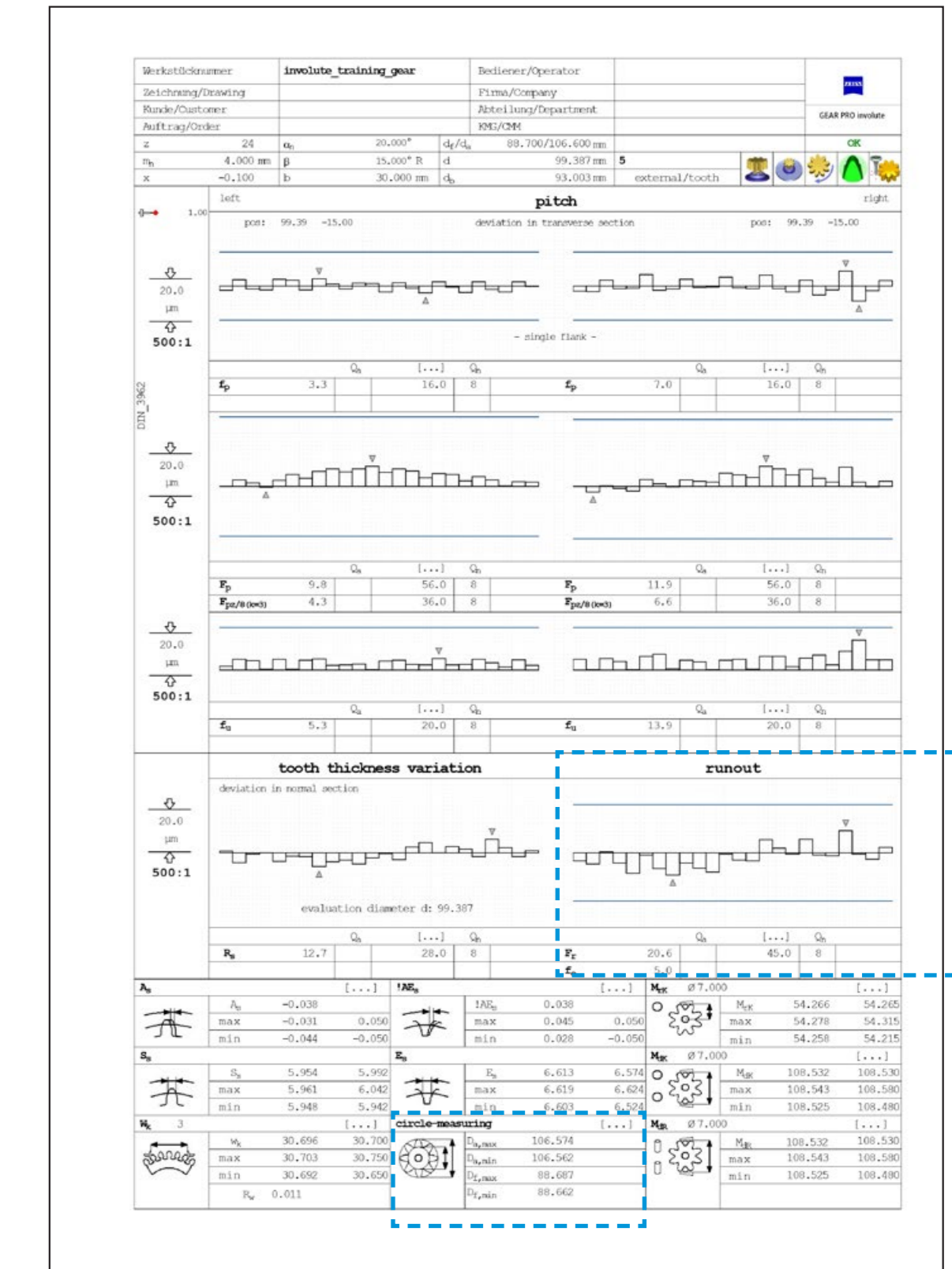
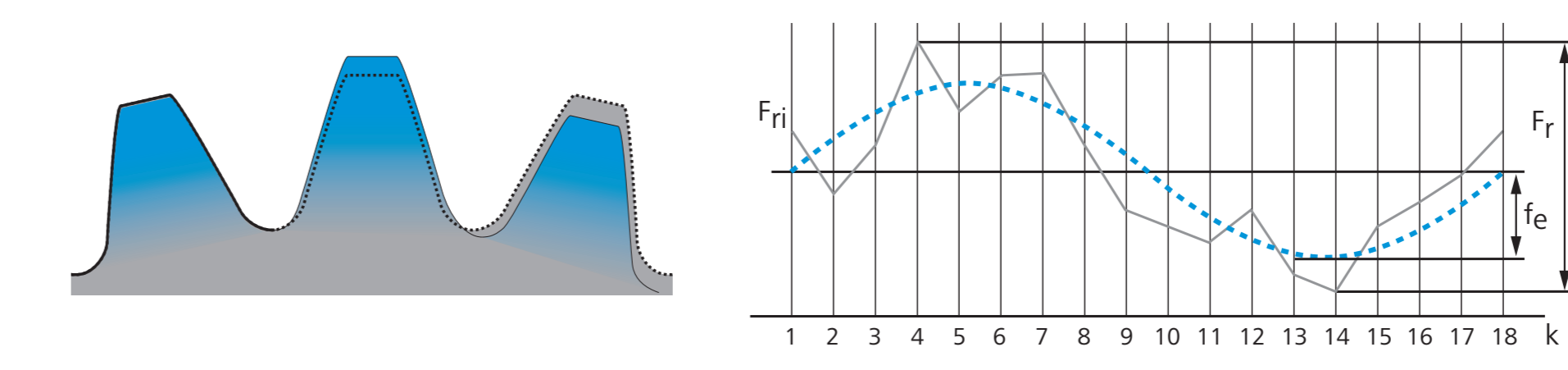

# Diameter

- d<sub>a</sub>** **Tip circle diameter**  
Greatest (smallest) diameter of an external gear (internal gear) at the tooth tip.
- d<sub>f</sub>** **Root circle diameter**  
Smallest (greatest) diameter of an external gear (internal gear) at the tooth root.

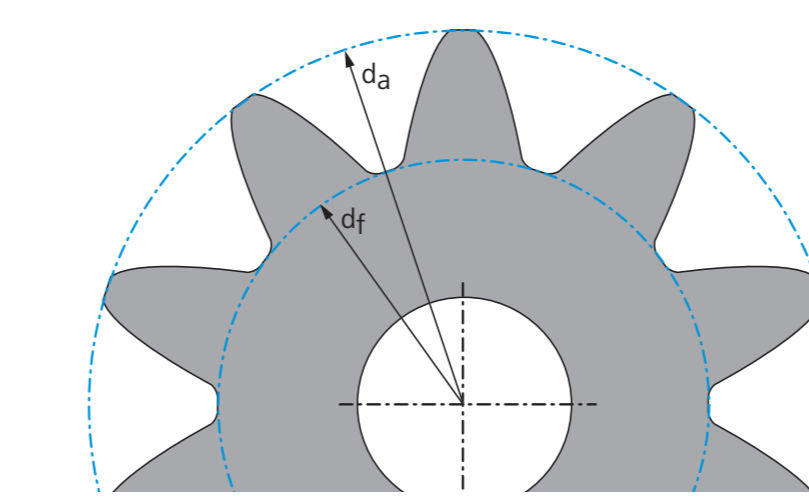

# Tooth thickness

- S** **Tooth thickness**  
Arc length of the distance of a right to a left flank in a transverse section plane on the reference section.
- M<sub>rK</sub>** **Radial dimension over/between one ball**  
Radial distance of the gear axis to the outermost (innermost) point of a defined measuring sphere fitted in a gap on both flanks of an external gear (internal gear).
- M<sub>dK</sub>** **Diametral dimension over/between two balls**  
**Diametral dimension over/between two pins**  
Greatest outermost (smallest innermost) distance of two defined measuring spheres/pins (cylinder) fitted in two opposing gaps on both flanks of an external gear (internal gear).
- W<sub>k</sub>** **Base tangent length over k teeth (gaps)**  
Distance of two parallel measuring planes that intersect a right and left flank over k teeth (gaps) of an external gear (internal gear) and also lie in a tangential plane on the base circle.

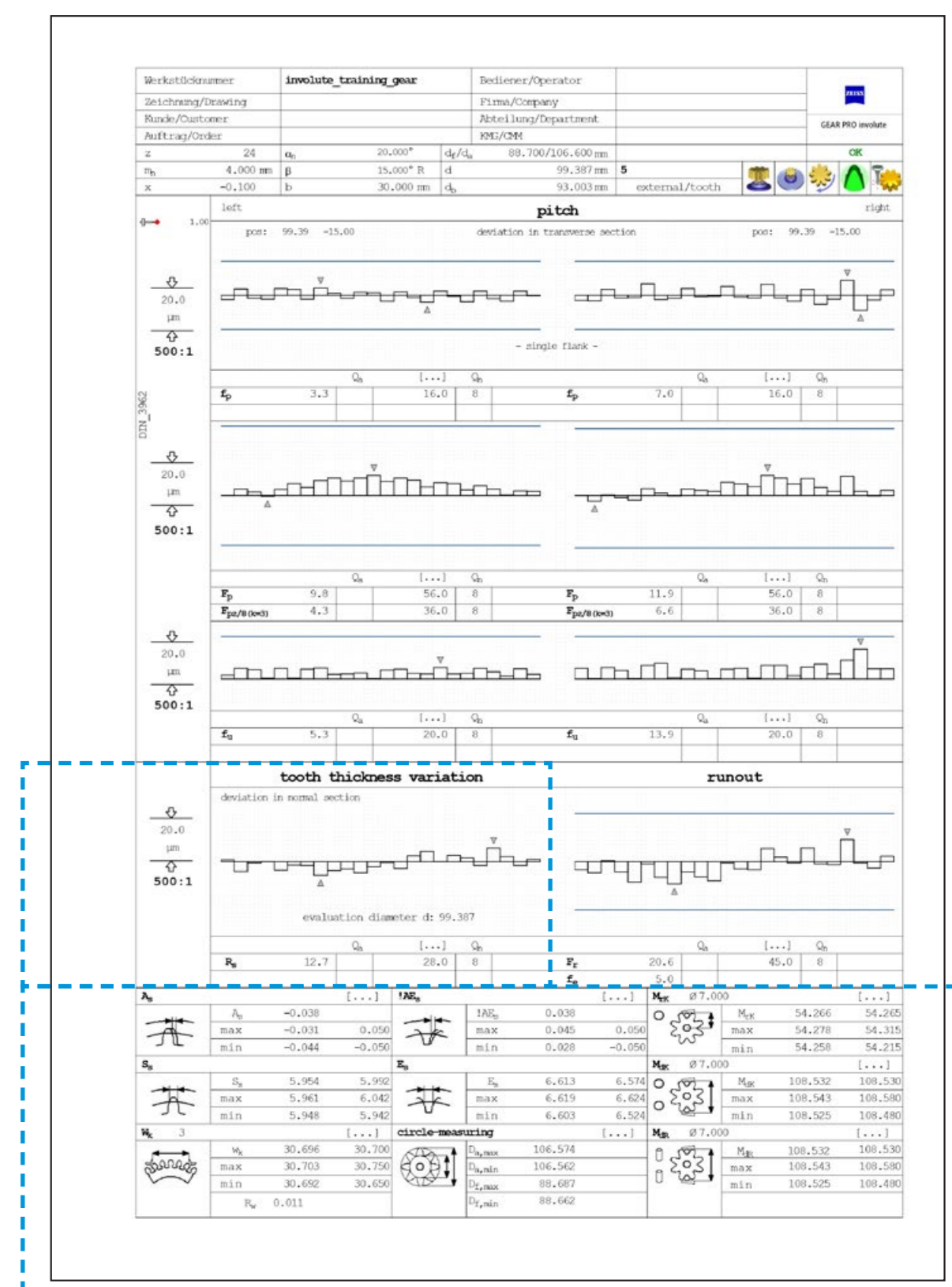
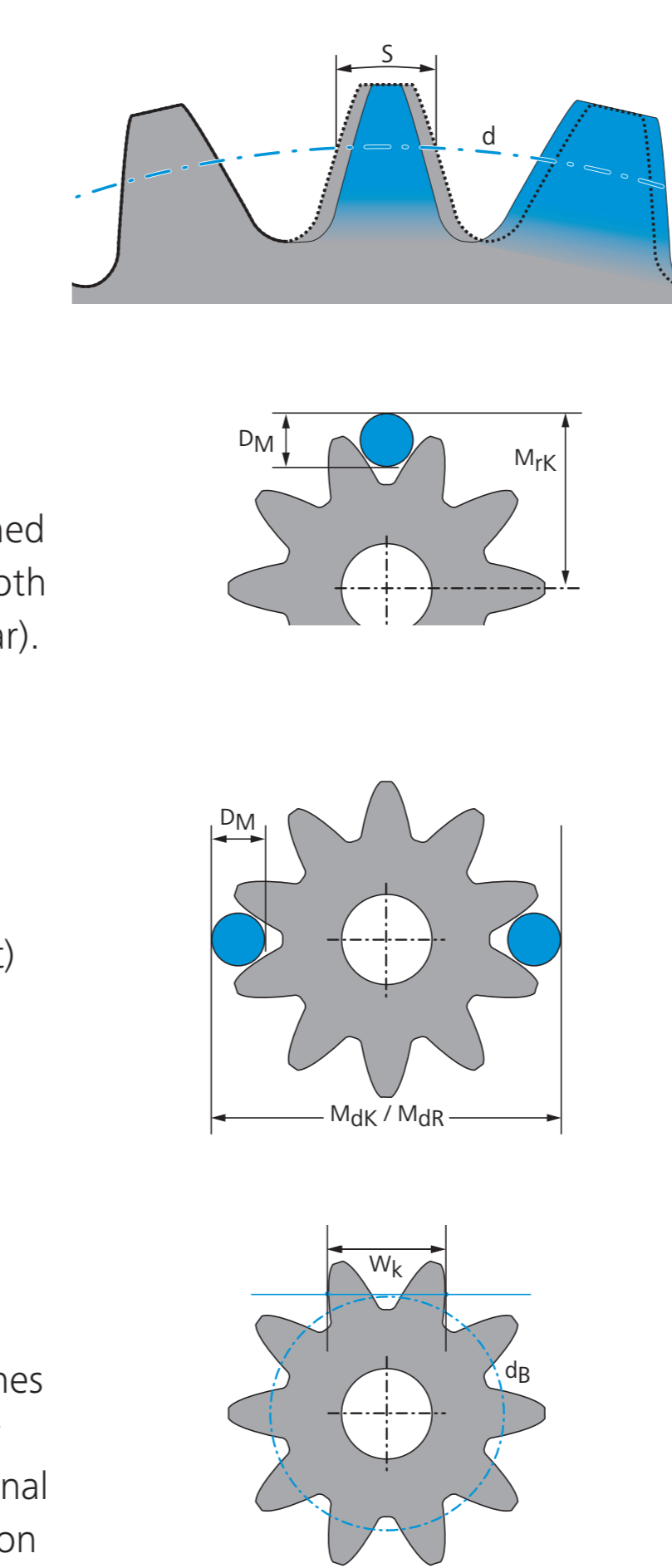

- i** Individual value
- j** Flank number
- k** Tooth/gap number
- n** Pitch number
- d** Reference diameter
- d<sub>b</sub>** Base diameter
- D<sub>M</sub>** Diameter of the measuring ball/pin (cylinder)